



**WALTHER**®



## Lever Action

Air rifle  
Cal. 4.5 mm (.177)

EN Operating instructions 2 - 9 | DE Bedienungsanleitung 10 - 17 | FR Mode d'emploi 18 - 25 | ES Manual de instrucciones 26 - 33  
IT Manuale d'istruzioni 34 - 41 | RU Инструкция по эксплуатации 42 - 49 | PL Instrukcja obsługi 50 - 57 | TR Kullanım Kılavuzu 58 - 65



EN



## SAFE HANDLING OF GUNS



### DESIGNATION

Learn how to handle your gun in a safe and proper manner. Remember that according to the basic rules of safety, touching a gun is the same as handling it.



### OPERATION

- Always handle a gun as if it were loaded.
- Keep your finger out of the trigger guard and put it on the trigger only when you want to shoot.
- Use only ammunition that has been approved for this weapon.
- Always point the muzzle in a safe direction.
- Shooting is permitted only within one's own home, on police-approved shooting ranges and on enclosed private property where there is no risk of projectiles leaving the premises. Keep the danger area of the projectile in mind.
- Never transport a loaded weapon. Load a weapon only when you intend to fire it.
- Never point a weapon at people or animals. Avoid ricocheting. Never shoot at smooth, hard surfaces or at water.
- Before shooting, make sure that the target and surroundings are safe.
- Always make sure that the gun is not loaded when you transport it or take it from another person.
- Make sure you can control the direction of the muzzle if you stumble or fall.
- Wear safety glasses when shooting.
- Store your weapon in a safe place and in unloaded condition. Keep it out of reach of unauthorized persons (untrained persons, children, persons under 18). Store ammunition separately.
- Give this gun only to persons over 18 who are thoroughly familiar with its use, and always include the instruction manual.
- Modifications or repairs should be made only by authorized companies or gunsmiths.
- Never put down a loaded gun.
- Do not give your weapon to someone else unless you have unloaded it.



### CARE



### SAFETY INSTRUCTIONS



## SAFETY INSTRUCTIONS



## CARE

EN



### CAUTION

For your own safety and the safety of others, carefully read these instructions before using this weapon. Buyers and owners must observe all rules concerning the use and ownership of air guns. Modifying this weapon may result in a change of its classification under weapons law and is therefore prohibited. In such cases the manufacturer's warranty will immediately become void.

#### Instructions for CO<sub>2</sub> lever action rifle

Make sure that your hands do not come into contact with discharged CO<sub>2</sub> gas. This may cause freezing of the skin. Do not expose the CO<sub>2</sub> cartridge to excessive heat and do not store it at temperatures exceeding 54°C. Always adhere to the warnings and safety instructions of the manufacturer on the gas cartridge in respect to handling and storage of a CO<sub>2</sub> gas container.

## WARRANTY

During the legal warranty period, which begins on the date of purchase, Umarex will repair or replace your weapon at no charge provided the defect was not caused by you. Return your weapon to an authorized dealer along with a description of the problem and proof of purchase.

The air guns manufactured by Umarex Sportwaffen GmbH & Co KG are made according to the regulations of the PTB (Physikalisch-Technische Bundesanstalt), German federal law, the CIP regulations and the technical know-how of Umarex Sportwaffen GmbH & Co. KG.

We will not assume any liability whatsoever if this product is exported to territories outside of Germany and as a consequence does not comply with domestic legal requirements of these territories. It will be the sole responsibility of the importer to ensure compliance with local laws and regulations.

## REPAIR

A weapon that does not work right is dangerous. Do-it-yourself repairs are difficult, and incorrect assembly can lead to dangerous malfunctions. Warning: Have your gun inspected and repaired only by an authorized dealer or gunsmith.

## CARE

Clean the external metal parts with a soft cloth that has been moistened with gun oil.

## PROBLEMS

Problems	Possible causes					
	88 g CO <sub>2</sub> cartridge	Dirt in barrel	88 g CO <sub>2</sub> cartridge not correctly screwed on	Extreme temperatures	Wrong ammunition	Ammunition not properly loaded
Poor shooting performance	●	●		●	●	●
Gun does not shoot	●		●		●	
Slow projectile	●	●		●	●	●



EN



DESIGNATION

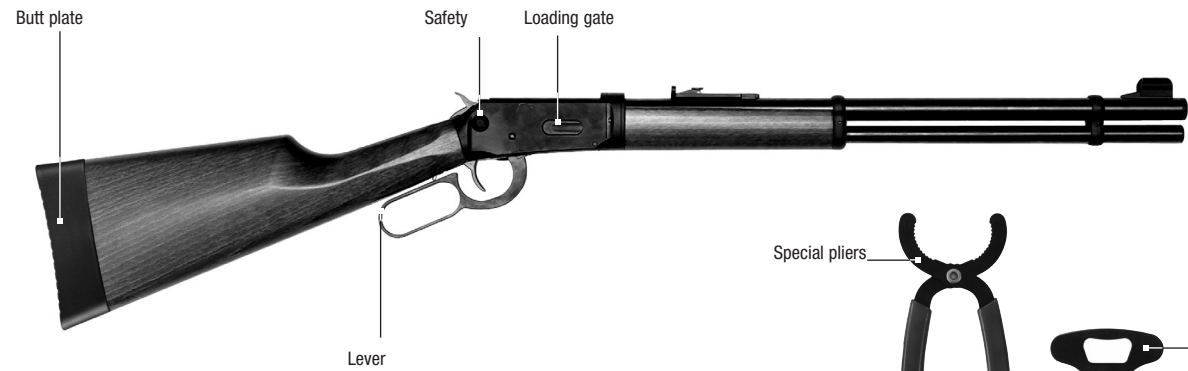
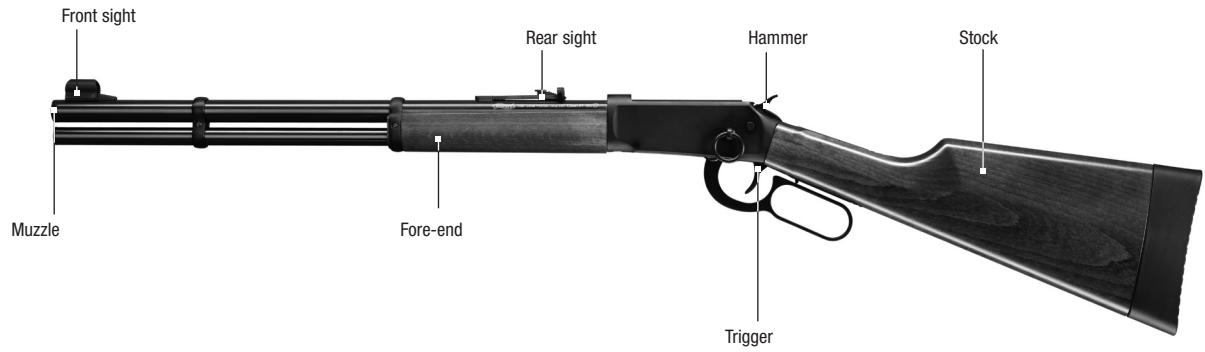



## TECHNICAL DATA



## SAFETY

EN

### LEVER ACTION

System	CO <sub>2</sub> lever action
Caliber	4.5 mm (.177)
Magazine capacity	8 rounds
Overall length	996 mm
Barrel length	480 mm (18.9 inches)
Weight (without cartridge)	2800 g
Muzzle velocity (energy)	175 m/s (7.5 J)
Propellant	88 g CO <sub>2</sub> cartridge
Trigger	Single Action Only
Sight	Vertically adjustable rear sight, laterally adjustable front sight

### CAUTION

Only handle the weapon when it is in decocked condition. Always make sure that the muzzle points in a safe direction.





## INSERTING AND CHANGING THE CO<sub>2</sub> CARTRIDGE



### CAUTION

There may be a minor discharge of gas when you remove the 88 g CO<sub>2</sub> cartridge. Remove the cartridge before storing the gun.

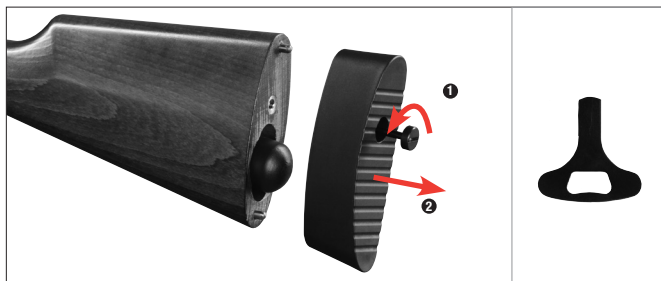

- 1 Loosen screw with key.
- 2 Pull off butt plate.

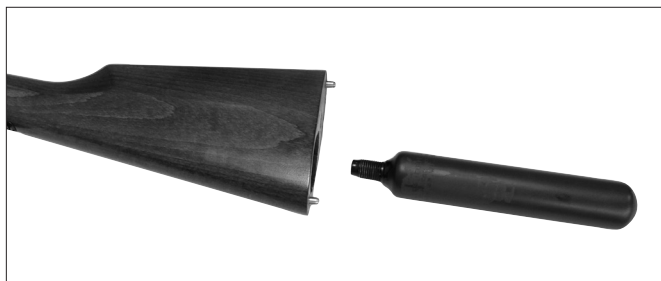

- 1 Screw 88 g CO<sub>2</sub> cartridge into stock, narrow end first.
- 2 Tighten with special pliers.



Unscrew 88 g CO<sub>2</sub> cartridge with special pliers.

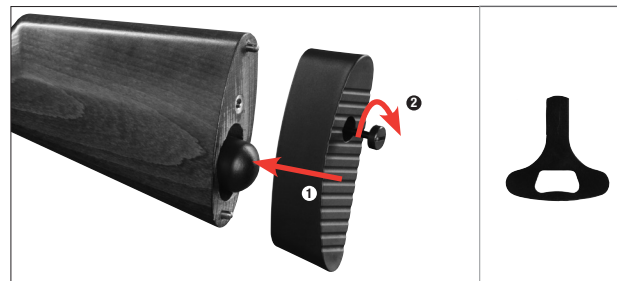

- 1 Replace butt plate.
- 2 Tighten screw with key.



## LOADING THE RIFLE



### CAUTION

Always make sure that the muzzle points in a safe direction.

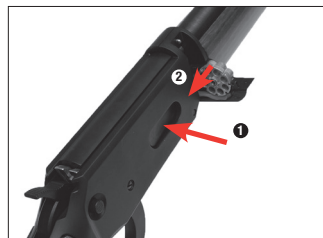

- ❶ Press in loading gate. Swivel arm comes out.
- ❷ Remove magazine.



- ❶ Insert loaded magazine. Make sure magazine is positioned correctly.
- ❷ Close swivel arm.

**IMPORTANT:** After inserting a new magazine, operate the lever to bring the magazine into position.



## LOADING THE CYLINDER MAGAZINE

EN



### CAUTION

Do not use BBs, darts or similar unsuitable ammunition. Use only 4.5 mm (.177) cal. pellets with a maximum length of 6.5 mm.

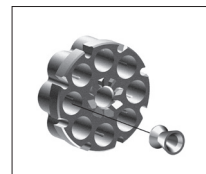

Load pellets into magazine.



Make sure pellets are positioned correctly.



## OPERATING THE LEVER AND SHOOTING

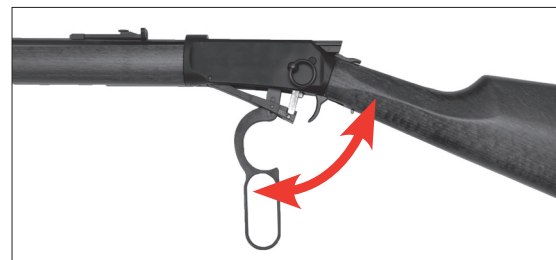

Move lever all the way down and then back until it engages.



EN



## OPERATING THE LEVER AND SHOOTING



JAMMS



### CAUTION

Shooting with insufficient CO<sub>2</sub> pressure can cause a pellet to lodge in the barrel.

Insert filled 88 g CO<sub>2</sub> cartridge. Shoot with empty magazine. The blocked pellet will fire.

If this procedure fails to resolve the problem, push the pellet out backwards using a cleaning brush.



- 1 Press lever against gun and hold it there while firing (trigger safety).
- 2 Pull trigger.





## ADJUSTING THE SIGHT

EN

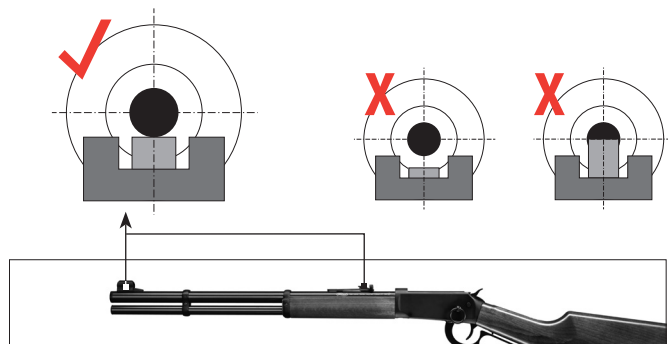

### Elevation adjustment (rear sight)

Elevation is adjusted by moving the catch on the rear sight.

If shots group high  
If shots group low

= push forward  
= push back

### Windage adjustment (front sight)

Windage is adjusted by moving the front sight. Remove the cap.

If shots group to the right  
If shots group to the left

= push to the right  
= push to the left

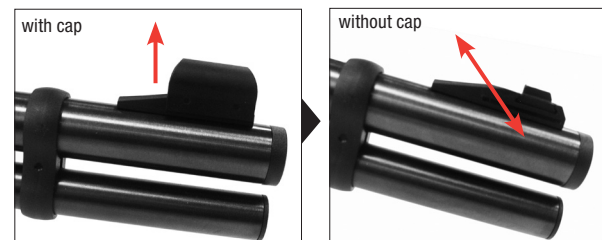
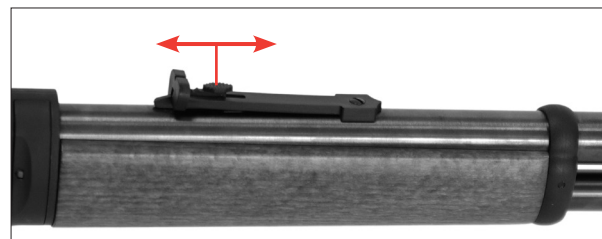



## SICHERER UMGANG MIT WAFFEN



### BENENNUNG



### BEDIENUNG



### PFLEGE



### SICHERHEITSHINWEISE

Sie sollten mit der richtigen, sicheren Handhabung Ihrer Waffe vertraut sein. Im Hinblick auf die Grundregeln zum sicheren Schießen bedenken Sie, dass jede Berührung mit der Waffe als Handhabung verstanden wird.

- Behandeln Sie jede Waffe so, als wäre sie geladen.
- Den Finger immer außerhalb des Abzugsbügels halten und nur zum Schuss an den Abzug legen.
- Verwenden Sie nur für diese Waffe vorgesehene Geschosse (Munition).
- Halten Sie die Mündung stets in eine sichere Richtung.
- Das Schießen ist nur in der eigenen Wohnung, auf polizeilich zugelassenen Schießständen und im befriedeten Besitztum erlaubt, wenn das Geschoss dieses beim Schuss nicht verlassen kann. Hierbei den Gefahrenbereich des Geschosses beachten.
- Transportieren Sie niemals eine geladene Waffe. Laden Sie nur, wenn Sie schießen möchten.
- Waffe niemals auf Menschen oder Tiere richten. Vermeiden Sie Querschläger. Schießen Sie niemals auf glatte, harte Oberflächen oder auf Wasserflächen.
- Vergewissern Sie sich vor dem Schuss, dass Ziel und Umgebungsbereich sicher sind.
- Kontrollieren Sie immer, ob die Waffe ungeladen ist, wenn Sie sie transportieren oder von einer anderen Person übernehmen.
- Vergewissern Sie sich, dass Sie auch beim Stolpern oder Stürzen die Richtung der Mündung kontrollieren können.
- Aus Sicherheitsgründen sollte beim Schießen eine Schutzbrille getragen werden.
- Bewahren Sie die Waffe stets sicher, ungeladen, geschützt vor unerlaubtem Zugriff Unbefugter (ungeschulte Personen, Kinder, Personen unter 18 Jahren) und getrennt von der Munition auf.
- Weitergabe dieser Waffe nur mit der Bedienungsanleitung und nur an Personen, wenn diese über 18 Jahre alt und mit der Handhabung dieser Waffe genauestens vertraut sind.
- Jegliche Veränderungen oder Reparaturen von Waffen sollten nur von fachkundigen Firmen oder vom Büchsenmacher durchgeführt werden.
- Legen Sie niemals eine geladene Waffe aus der Hand.
- Geben Sie nur entladene Waffen an andere Personen weiter.



## SICHERHEITSHINWEISE



## PFLEGE

DE



## ACHTUNG

Zu Ihrer eigenen und zur Sicherheit anderer lesen Sie die Bedienungsanleitung vollständig und sorgfältig durch, bevor Sie mit der Waffe erstmalig hantieren. Käufer und Besitzer haben die Pflicht, alle Regeln über den Gebrauch und den Besitz von Druckluftwaffen zu befolgen. Jede Änderung an dieser Waffe kann zu einer Änderung der waffenrechtlichen Einstufung führen und ist somit unzulässig. Die Gewährleistung des Herstellers erlischt in diesem Fall sofort. **Dieses CO<sub>2</sub>-Gewehr ist frei erwerbbar ab 18 Jahren und älter.**

### Hinweise CO<sub>2</sub>-Gewehr Lever Action

Achten Sie darauf, dass Ihre Hände nicht mit austretendem CO<sub>2</sub>-Gas in Berührung kommen. Bei Kontakt mit der Haut kann es zu Erfrierungen kommen. Setzen Sie die CO<sub>2</sub>-Kapsel keiner großen Hitze aus und lagern Sie diese Behälter nicht bei Temperaturen über 54°C. Halten Sie sich immer an die auf der CO<sub>2</sub>-Kapsel aufgedruckten Warn- und Sicherheitshinweise des Herstellers bezüglich Umgang und Lagerung der CO<sub>2</sub>-Kapsel.

## GARANTIE

Innerhalb des gesetzlich festgelegten Zeitraumes repariert oder ersetzt Ihnen die Firma Umarex Sportwaffen GmbH & Co. KG Ihre Waffe kostenlos, falls der Defekt nicht durch Eigenverschulden aufgetreten ist. Geben Sie die Waffe einem autorisierten Händler, beschreiben Sie ihm das Problem und fügen Sie den entsprechenden Kaufbeleg bei.

Die von Umarex Sportwaffen GmbH & Co. KG hergestellten Druckluftwaffen werden gemäß den Zulassungsvorschriften der Physikalisch-Technischen Bundesanstalt (PTB), dem Bundesgesetz, den CIP-Vorschriften und dem waffentechnischen Know-how der Firma Umarex Sportwaffen GmbH & Co. KG hergestellt.

Somit übernehmen wir keine Haftung, falls diese Ware nach dem Export ins Ausland nicht den dort geltenden Rechtsvorschriften entsprechen sollte und dem Besitzer/Käufer juristische Schwierigkeiten und Konsequenzen daraus entstehen sollten.

## REPARATUR

Eine Waffe, die nicht einwandfrei funktioniert, ist gefährlich. Es ist schwierig, eine Waffe selbst zu reparieren, und ein falscher Zusammenbau kann zu gefährlichen Funktionsstörungen führen. **Achtung:** Lassen Sie die Waffe nur von einem autorisiertem Fachhändler / Büchsenmacher überprüfen und reparieren.

## PFLEGE

Reinigen Sie die äußeren Metallteile mit einem weichen Tuch, welches zuvor mit Waffenöl benetzt wurde.

## PROBLEME

Probleme	Mögliche Gründe					
	88 g CO <sub>2</sub> -Kapsel leer	Lauf verschmutzt	88 g CO <sub>2</sub> -Kapsel nicht richtig aufgeschraubt	Extreme Temperaturen	Falsche Munition	Munition falsch geladen
schlechte Schussleistung	●	●		●	●	●
Waffe schießt nicht	●		●		●	
geringe Geschwindigkeit	●	●		●	●	●



DE



## BENENNUNG

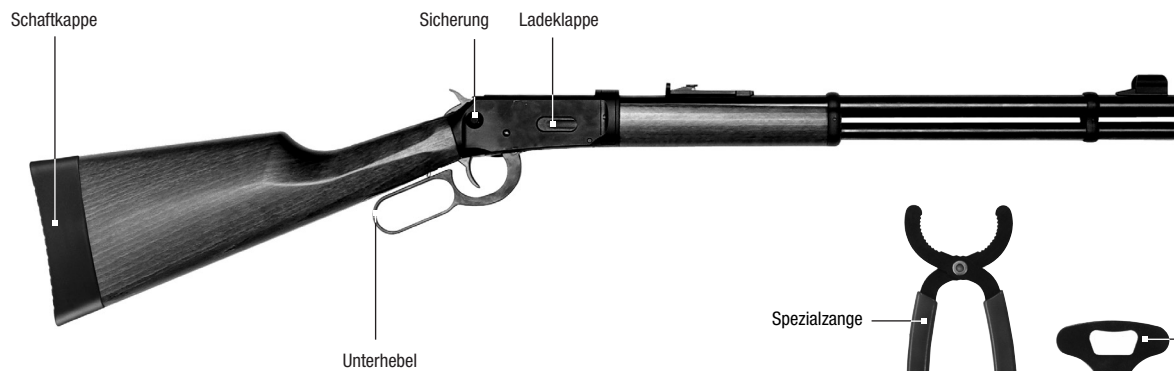
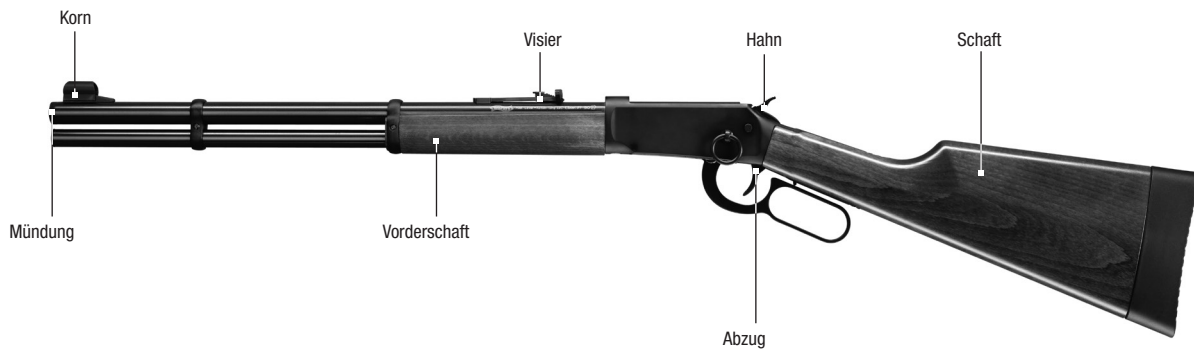

**LEVER ACTION**

System	CO <sub>2</sub> -Lever-Action
Kaliber	4.5 mm (.177)
Magazinkapazität	8 Schuss
Gesamtlänge	996 mm
Lauflänge	480 mm (18.9 inch)
Gewicht (ohne Kapsel)	2800 g
Mündungsgeschwindigkeit (Energie)	175 m/s (7.5 J)
Antrieb	88g CO <sub>2</sub> -Kapsel
Abzug	Single-Action-Only
Visier	höhenverstellbare Kimme, seitenverstellbares Korn

 **ACHTUNG**

Hantieren Sie nur mit der Waffe, wenn diese gesichert ist. Achten Sie stets darauf, dass die Mündung in eine sichere Richtung zeigt.





## EINSETZEN / AUSTAUSCHEN DER CO<sub>2</sub>-KAPSEL

### ACHTUNG

Beim Herausnehmen der 88 g CO<sub>2</sub>-Kapsel kann es zu einem leichten Austritt von CO<sub>2</sub> kommen. Für die Lagerung der Waffe 88 g CO<sub>2</sub>-Kapsel entnehmen!

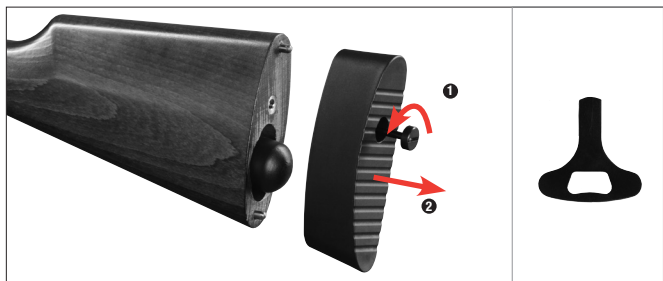

- 1 Schraube mit Schlüssel lösen.
- 2 Schaftkappe nach hinten abziehen.



- 1 88 g CO<sub>2</sub>-Kapsel mit dem schlanken Ende zuerst in den Schaft schrauben.
- 2 Mit Spezialzange festziehen.



88 g CO<sub>2</sub>-Kapsel mit Spezialzange herausdrehen.

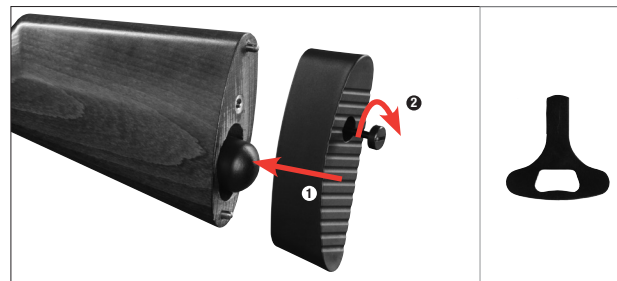

- 1 Schaftkappe aufsetzen.
- 2 Schraube mit Schlüssel festziehen.



## LADEN DES GEWEHRS

### ACHTUNG

Achten Sie stets darauf, dass die Mündung in eine sichere Richtung zeigt.



- ❶ Ladeklappe eindrücken.  
Schwenkarm schwenkt auf.
- ❷ Trommel entnehmen.



- ❶ Geladene Trommel einsetzen.  
Korrekte Position der Trommel beachten (Rastnasen hinten).
- ❷ Schwenkarm schließen.

**WICHTIG:** Nach jedem Einsetzen einer neuen Trommel muss einmal repetiert werden, um die Trommel in Position zu bringen.



## LADEN DES TROMMELMAGAZINS

DE

### ACHTUNG

Verwenden Sie keine Stahlrundkugeln (so genannte BBs), Federbolzen oder ähnlich ungeeignete Geschosse. Nur Diabolos cal. 4,5 mm (.177) mit maximaler Geschosslänge von 6,5 mm verwenden.

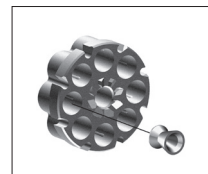

Trommel mit Diabolos laden.

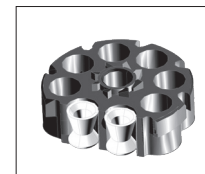

Korrekte Position der Diabolos beachten.



## REPETIEREN UND SCHIESSEN

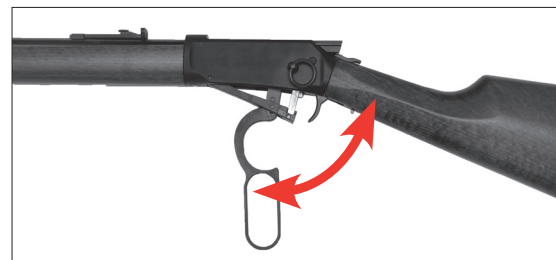

Unterhebel ganz nach unten und wieder nach oben bewegen bis er einrastet.



DE



## REPETIEREN UND SCHIESSEN



## LADEHEMMUNG



### ACHTUNG

Das Schießen mit einem Gewehr mit zu geringem CO<sub>2</sub>-Druck kann dazu führen, dass ein Diabolo im Lauf stecken bleibt.

Gefüllte 88 g CO<sub>2</sub>-Kapsel einsetzen. Mit leerem Trommelmagazin schießen.

Das feststehende Diabolo wird verschossen.

Wird das Problem nicht behoben, im Lauf befindliches Diabolo mit einer Reinigungsbürste nach hinten aus dem Gewehr schieben.

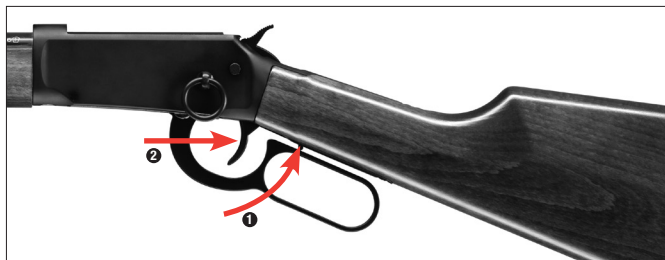

- 1 Unterhebel an das Gewehr andrücken und beim Schießen gedrückt halten (Abzugsicherung).
- 2 Abzug ziehen.





## VISIEREINSTELLUNGEN

DE

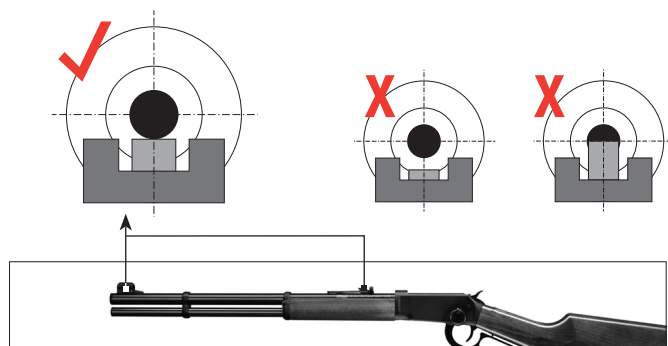

### Höhenverstellung (Visier)

Die Höhenverstellung erfolgt durch Verschieben der Raste am Visier.

Hochschuss

= Verstellung nach vorne schieben

Tiefschuss

= Verstellung nach hinten schieben

### Seitenverstellung (Korn)

Die Seitenverstellung erfolgt durch Verschieben des Korns. Hierzu die Kappe abnehmen.

Rechtsschuss

= nach rechts schieben

Linksschuss

= nach links schieben

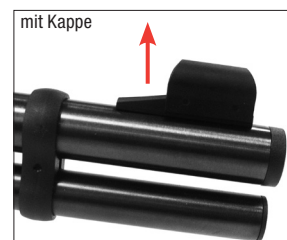
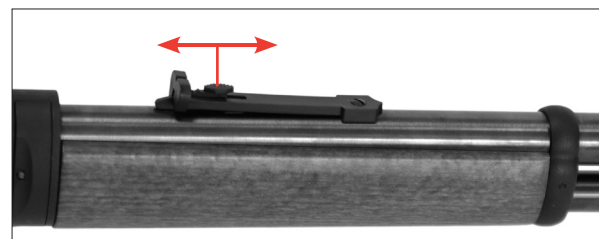



## DÉSIGNATION DES PIÈCES



## UTILISATION



## ENTRETIEN



## CONSIGNES DE SÉCURITÉ

Vous devez être habitué à manipuler votre arme correctement et de manière sûre. En considération des règles de base pour tirer en toute sécurité, n'oubliez pas que tout contact avec l'arme est considéré comme une manipulation.

- Maniez toujours l'arme comme si elle était chargée.
- Tenez toujours votre doigt en dehors du pontet et ne le mettez sur la détente qu'au moment de tirer.
- Utilisez seulement les munitions prévues pour cette arme.
- Pointez toujours l'arme dans une direction sûre.
- Le tir n'est autorisé que dans votre propriété, dans des zones de tir autorisées par la police, et dans une propriété sécurisée, à condition que les projectiles ne puissent pas sortir de cette propriété lors du tir. Pour cela, veuillez prêter attention à la portée des projectiles.
- Ne transportez jamais une arme chargée. Armez-la seulement lorsque vous êtes prêt à tirer.
- Ne pointez jamais l'arme vers des personnes ou des animaux. Évitez les tirs pouvant ricocher. Ne tirez jamais sur des surfaces lisses ou dures, ou encore sur des étendues d'eau.
- Avant de tirer, assurez-vous que la cible et les alentours ne présentent aucun danger.
- Vérifiez toujours que l'arme est déchargée avant de la transporter ou lorsque vous la recevez d'autrui.
- Veillez à maîtriser la direction dans laquelle l'arme est pointée même si vous trébuchez ou tombez.
- Pour des raisons de sécurité, portez des lunettes de protection lorsque vous tirez.
- Rangez toujours l'arme déchargée, sûreté enclenchée, séparée des munitions, et hors de portée des personnes non autorisées (personnes non formées au maniement, enfants, mineurs).
- Remettez cette arme seulement à des personnes de plus de 18 ans et le plus possible formées au maniement de cette arme, et transmettez-la toujours avec le mode d'emploi.
- Toute modification ou réparation de l'arme doit être effectuée par une entreprise spécialisée ou un armurier.
- Ne posez jamais une arme chargée.
- Déchargez toujours l'arme avant de la remettre à d'autres personnes.



## CONSIGNES DE SÉCURITÉ ENTRETIEN

FR



### ATTENTION

Pour votre sécurité et celle des autres, veuillez lire attentivement tout le mode d'emploi avant de tirer pour la première fois avec cette arme. Les acheteurs et possesseurs d'armes ont pour obligation de respecter tous les règlements relatifs à l'utilisation et à la possession d'armes à air comprimé. Il est interdit de modifier l'arme, ceci pouvant entraîner un changement de classification légale de l'arme. En cas de non-respect de cette règle, la garantie du fabricant expire immédiatement.

#### Remarques concernant la carabine au CO<sub>2</sub> Lever Action

Veillez à ce que vos mains n'entrent pas en contact avec le gaz CO<sub>2</sub> qui s'échappe. Le contact avec la peau peut entraîner des gelures. Ne soumettez pas les cartouches de CO<sub>2</sub> à une chaleur trop importante et ne les stockez pas à des températures supérieures à 54 °C. Respectez toujours les consignes de sécurité et avertissements figurant sur la cartouche de CO<sub>2</sub> relatifs à l'utilisation et au stockage de cartouches de CO<sub>2</sub>.

## GARANTIE

La société Umarex s'engage à réparer ou à remplacer votre arme durant une période déterminée légalement à compter de la date d'achat, à condition que vous ne soyez pas responsable du défaut. Pour cela, remettez l'arme à un revendeur autorisé, décrivez-lui le problème et joignez le justificatif d'achat correspondant.

Les armes à air comprimé de la société Umarex Sportwaffen GmbH & Co KG sont fabriquées conformément aux directives de conformité de l'institut allemand « Physikalisch-Technische Bundesanstalt (PTB) », à la loi fédérale, aux prescriptions CIP et au savoir-faire technique de la société Umarex Sportwaffen GmbH & Co KG dans le domaine des armes.

Ainsi, nous ne pouvons être tenus responsables si, après exportation à l'étranger, cette marchandise ne répond pas aux prescriptions légales en vigueur dans le pays en question et si le possesseur/acheteur doit pour cette raison faire face à des difficultés juridiques ou toute autre conséquence pouvant découler de ce fait.

## RÉPARATION

Une arme qui ne fonctionne pas correctement est dangereuse. Il est difficile de réparer soi-même une arme et un assemblage incorrect peut entraîner de dangereux dysfonctionnements. Attention : ne faites vérifier et réparer votre arme que par un spécialiste / armurier autorisé !

## ENTRETIEN

Nettoyez les pièces métalliques extérieures à l'aide d'un chiffon doux préalablement imbibé d'huile pour armes.

## DYSFONCTIONNEMENTS

	Causes possibles					
	cartouche de CO <sub>2</sub> de 88 g	canon encrassé	cartouche de CO <sub>2</sub> de 88 g incorrectement vissée	températures extrêmes	mauvaises munitions	munitions mal chargées
DYSFONCTIONNEMENTS						
mauvaise performance de tir	●	●		●	●	●
l'arme ne tire pas	●		●		●	
faible vitesse du projectile	●	●		●	●	●



FR



## DÉSIGNATION DES PIÈCES

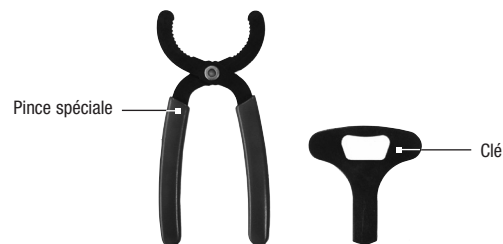
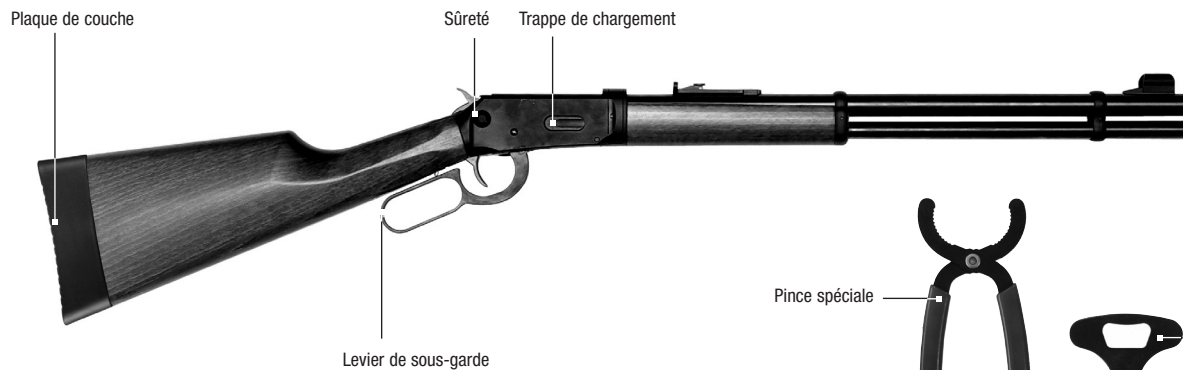
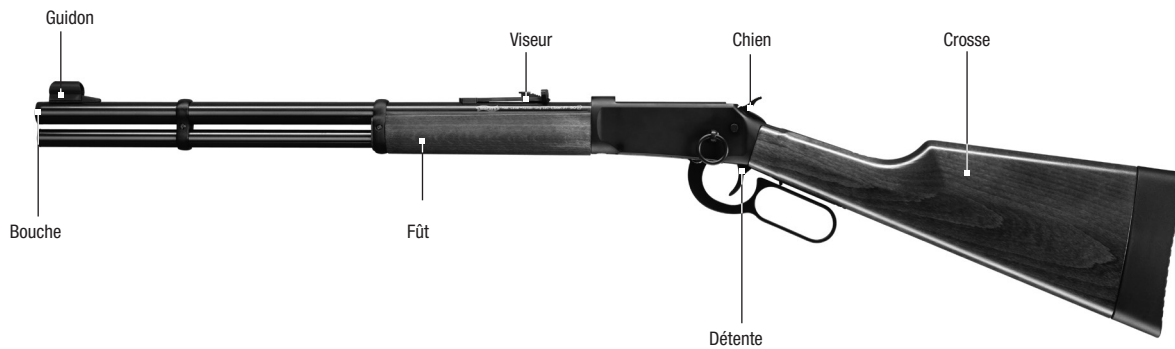



## CARACTÉRISTIQUES TECHNIQUES



## SÛRETE

FR

LEVER ACTION	
Système	Lever Action au CO <sub>2</sub>
Calibre	4,5 mm (.177)
Capacité du chargeur	8 tirs
Longueur totale	996 mm
Longueur du canon	480 mm (18,9 pouces)
Poids (sans cartouche)	2800 g
Vitesse initiale (énergie)	175 m/s (7,5 J)
Propulsion	Cartouche de CO <sub>2</sub> de 88 g
Détente	Single-Action-Only (simple action)
Viseur	Hausse réglable en hauteur Guidon réglable en hauteur

### ATTENTION

Ne manipulez l'arme que lorsque la sûreté est enclenchée. Veuillez à toujours pointer la bouche de l'arme dans une direction sûre.





FR



## MISE EN PLACE / REMPLACEMENT DE LA CARTOUCHE DE CO<sub>2</sub>

### ATTENTION

Un peu de CO<sub>2</sub> peut s'échapper lors du retrait de la cartouche de CO<sub>2</sub> de 88 g. Enlevez la cartouche de CO<sub>2</sub> de 88 g avant de ranger l'arme !

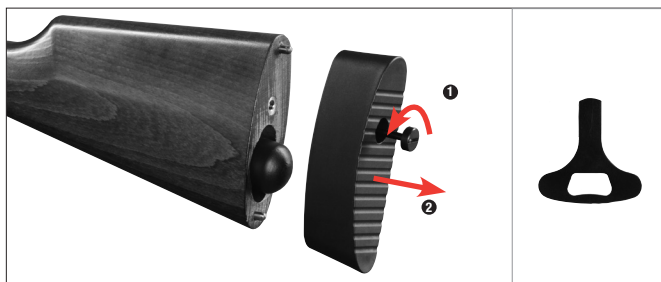

- 1 Dévissez la vis à l'aide de la clé.
- 2 Retirez la plaque de couche par l'arrière.



- 1 Vissez la cartouche de CO<sub>2</sub> de 88 g dans la crosse, l'extrémité la plus mince vers l'avant.
- 2 Vissez à fond avec la pince spéciale.



Retirez la cartouche de CO<sub>2</sub> de 88 g à l'aide de la pince spéciale.

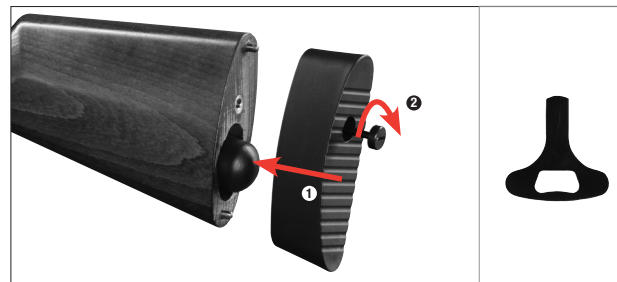

- 1 Remplacez la plaque de couche.
- 2 Vissez à fond avec la clé.



## CHARGEMENT DE LA CARABINE

### ATTENTION

Veillez à toujours pointer la bouche de l'arme dans une direction sûre.



- 1 Enfoncez la trappe de chargement.  
Le logement du barillet s'ouvre.
- 2 Retirez le barillet.



- 1 Placez le barillet chargé.  
Veillez à la bonne position du barillet.
- 2 Refermez le logement.

**IMPORTANT :** un mouvement de répétition doit être effectué après chaque mise en place d'un nouveau barillet afin que celui-ci se mette en position.



## CHARGEMENT DU BARILLET

FR

### ATTENTION

N'utilisez pas de billes rondes en acier (appelées BB), de fléchettes ou tout autre projectile similaire inapproprié. Utilisez exclusivement des diabolos de calibre 4,5 mm (.177) d'une longueur maximale de 6,5 mm.

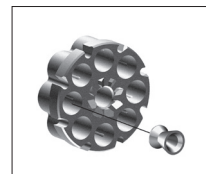

Placez les diabolos dans le barillet.

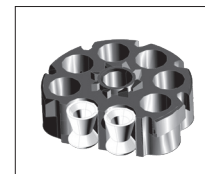

Prêtez attention à la bonne position des diabolos.



## EFFECTUER UN MOUVEMENT DE REPETITION ET TIRER

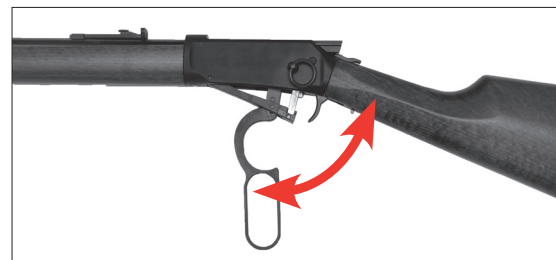

Abaissez complètement le levier de sous-garde et remontez-le jusqu'à ce qu'il s'enclenche.



FR



EFFECTUER UN MOUVEMENT DE REPETITION ET TIRER



COINCEMENT



### ATTENTION

Lorsque vous tirez avec une arme dont la pression de CO<sub>2</sub> est insuffisante, un diabolo peut rester coincé dans le canon.

Placez la cartouche de CO<sub>2</sub> de 88 g. Tirez avec le barillet vide.  
Le diabolo coincé est alors tiré.

Si le problème n'est toujours pas résolu, faites sortir le diabolo du canon en le poussant vers l'arrière à l'aide d'un écouvillon.

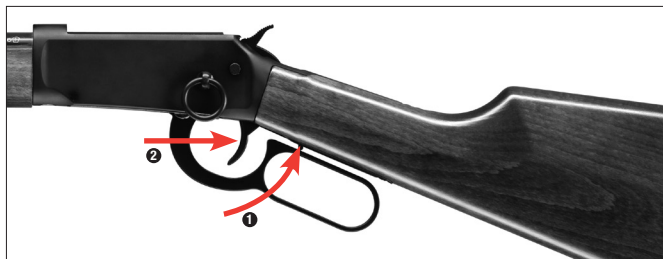

- 1 Appuyez le levier de sous-garde contre la carabine et maintenez-le lors du tir (sûreté de détente).
- 2 Appuyez sur la détente





## RÉGLAGES DU DISPOSITIF DE VISÉE

FR

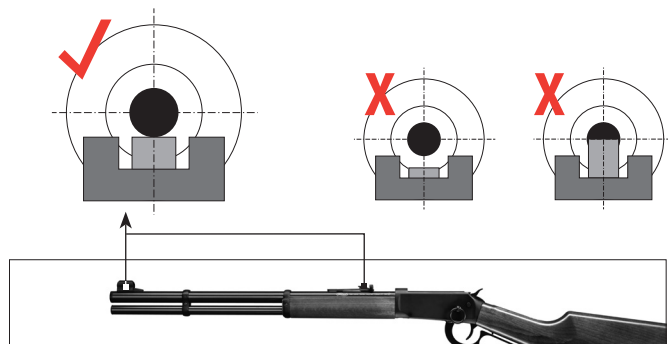

### Réglage en hauteur (hausse)

Le réglage en hauteur est réalisé en déplaçant le cran sur la hausse.

Tir trop haut

= déplacement vers l'avant

Tir trop bas

= déplacement vers l'arrière

### Réglage latéral (guidon)

Le réglage latéral est réalisé en déplaçant le guidon. Pour ce faire, retirez le capuchon.

Tir trop à droite

= poussez vers la droite

Tir trop à gauche

= poussez vers la gauche

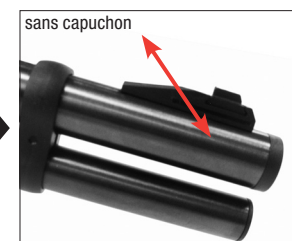
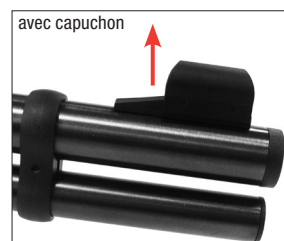
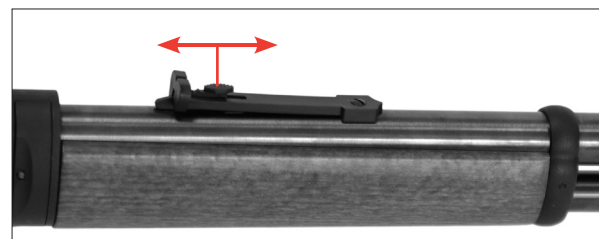



## MANEJO SEGURO DE ARMAS



### DESIGNACIÓN



### MANEJO



### CUIDADOS



### INSTRUCCIONES DE SEGURIDAD

Deberá estar familiarizado con el manejo correcto y seguro de su arma. Con respecto a las reglas básicas para disparar con seguridad, considere cada contacto con el arma como parte de su manejo.

- Trate el arma como si siempre estuviera cargada.
- Mantenga el dedo siempre fuera del gatillo y colóquelo solamente cuando vaya a disparar.
- Use únicamente los proyectiles (munición) previstos para esta arma.
- Mantenga la boca del arma siempre en una dirección segura.
- Sólo está permitido disparar el arma en la vivienda del propietario o en las zonas de tiro autorizadas por la policía, siempre y cuando el proyectil no pueda sobrepasar el área de tiro. Para ello, tenga presente siempre la distancia máxima de peligro del proyectil.
- Nunca transporte el arma cargada. Cárguela solamente cuando tenga intención de disparar.
- Nunca apunte con el arma hacia personas o animales. Evite los disparos en los que el proyectil pueda rebotar: nunca dispare sobre superficies lisas y duras o el agua.
- Antes de disparar, asegúrese de que el objetivo y el entorno sean seguros.
- Al transportar o recibir el arma de otra persona, compruebe siempre que ésta esté descargada.
- Asegúrese de que puede controlar la dirección a la que apunta la boca del arma incluso si tropezara o cayese.
- Por motivos de seguridad, deberá usar siempre gafas protectoras cuando vaya a disparar.
- Guarde el arma siempre descargada, separada de la munición y en lugar seguro para evitar que personas no aptas (personas sin formación, niños) puedan acceder a ella.
- Entregue esta arma, junto con las instrucciones de uso, únicamente a aquellas personas mayores de 18 años que estén perfectamente familiarizadas con su manejo.
- Cualquier modificación o reparación del arma deberá llevarla a cabo una empresa especializada o un armero.
- Nunca deje sin vigilancia un arma cargada.
- Siempre que entregue un arma a otra persona, asegúrese de que está descargada.



## INSTRUCCIONES DE SEGURIDAD CUIDADOS

ES



### ATENCIÓN

Por su propia seguridad y la de los demás, lea detenidamente las instrucciones de uso completas antes de disparar el arma por primera vez. Vendedores y compradores están obligados a cumplir todas las normas de uso y posesión de armas de aire comprimido. Queda prohibida cualquier modificación de esta arma, ya que ello podría implicar un cambio en su clasificación legal. En caso de modificación quedaría extinguida de inmediato la garantía del fabricante.

#### Advertencias sobre la carabina de CO<sub>2</sub> Lever Action

Procure que sus manos no entren en contacto con el CO<sub>2</sub> en caso de fuga, ya que un eventual contacto con la piel puede causar congelación. No exponga el cartucho de CO<sub>2</sub> a un calor excesivo ni lo guarde a temperaturas superiores a los 54°C. Observe siempre las advertencias e instrucciones de seguridad del fabricante, impresas en el cartucho de CO<sub>2</sub> sobre el manejo y almacenamiento del mismo.

### GARANTÍA

La empresa Umarex Sportwaffen GmbH & Co KG se responsabiliza de reparar o sustituir su producto sin coste alguno en el plazo legalmente fijado a partir de la fecha de compra, siempre que el defecto no sea responsabilidad del propio usuario. Entregue el arma a un comerciante autorizado, describale el problema y adjunte el correspondiente comprobante de compra.

Las armas de aire comprimido de la empresa Umarex Sportwaffen GmbH & Co KG se fabrican de conformidad con las normas de homologación del Instituto Federal PTB (Physikalisch-Technischer Bundesanstalt), con la Ley Federal alemana, la normativa que establece el centro CIP y la experiencia en fabricación de armas de empresa Umarex Sportwaffen GmbH & Co KG.

Por eso, no asumimos ninguna responsabilidad en el caso de que al exportar el arma a un país extranjero, ésta no cumpliera con la normativa legal local y el propietario o comprador tuviera que responder jurídicamente por dicho incumplimiento.

### REPARACIONES

Un arma que no funcione perfectamente es peligrosa. Es difícil reparar uno mismo un arma, y un ensamblaje incorrecto puede producir anomalías de funcionamiento peligrosas. Atención: La comprobación y reparación del arma sólo pueden llevarla a cabo especialistas autorizados o un armero.

### CUIDADOS

Limpie las piezas metálicas exteriores con un trapo suave, humedecido con aceite para armas.

### PROBLEMAS

PROBLEMAS	Posibles causas					
	Cartucho de CO <sub>2</sub> de 88 g vacío	Cañón sucio	Cartucho de CO <sub>2</sub> de 88 g mal atornillado	Temperaturas extremas	Munición inadecuada	Munición mal cargada
Potencia de disparo deficiente	●	●		●	●	●
El arma no dispara	●		●		●	
Escasa velocidad de disparo	●	●		●	●	●



ES



## DESIGNACIÓN

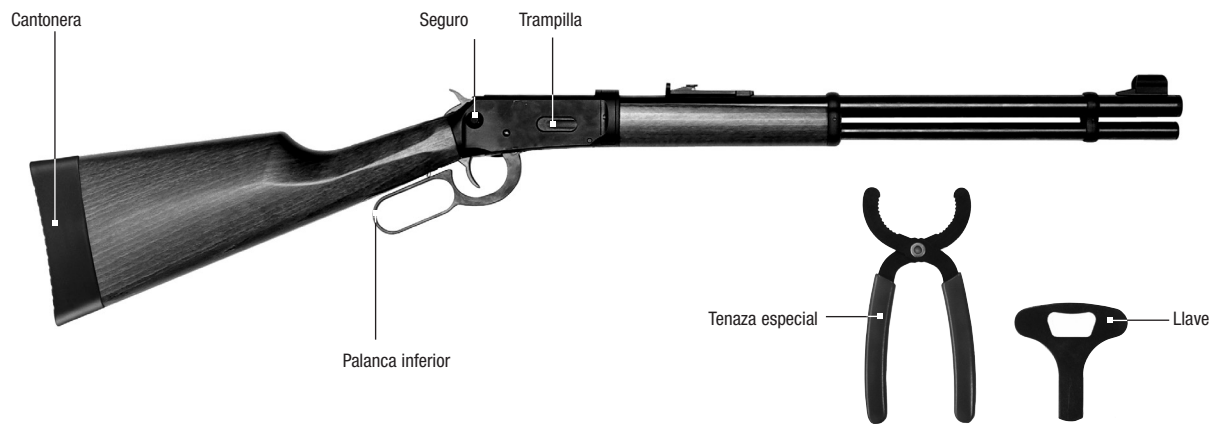
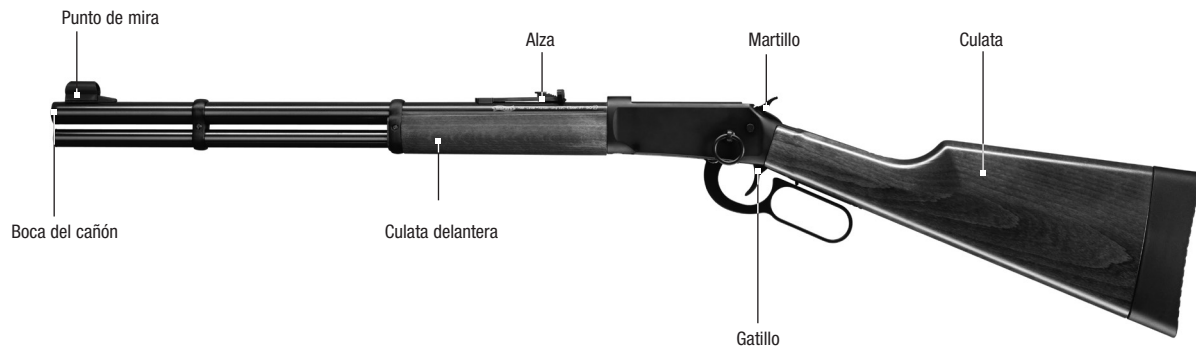



ESPECIFICACIONES



SEGURO

ES

### LEVER ACTION

Sistema	Lever Action de CO <sub>2</sub>
Calibre	4.5 mm (.177)
Capacidad del cargador	8 disparos
Longitud total	996 mm
Longitud del cañón	480 mm (18.9 pulgadas)
Peso (sin cartucho)	2800 g
Velocidad inicial (energía)	175 m/s (7.5 J)
Propulsión	Cartucho de 88g CO <sub>2</sub> de 88 g
Gatillo	Sólo acción simple
Alza	Alza de altura regulable Punto de mira de altura regulable

### ATENCIÓN

Manipule la pistola sólo cuando esté asegurada. Procure que la boca del cañón apunte siempre en una dirección segura.





ES



## INSERTAR / REEMPLAZAR EL CARTUCHO DE CO<sub>2</sub>



### ATENCIÓN

Al extraer el cartucho de CO<sub>2</sub> de 88 g es posible que se escape una pequeña cantidad de gas. ¡Para guardar el arma extraiga el cartucho de CO<sub>2</sub> de 88 g!

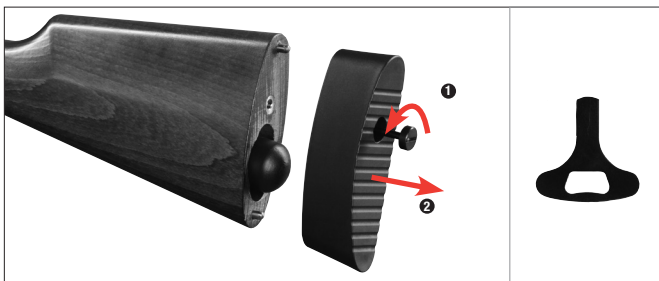

- 1 Aflojar el tornillo con la llave.
- 2 Extraer la cantonera hacia atrás.



- 1 Atornillar en la culata el cartucho de CO<sub>2</sub> de 88 g, con el extremo más fino hacia delante.
- 2 Apretar con la tenaza especial.



Desenroscar el cartucho de CO<sub>2</sub> de 88 g con la tenaza especial.

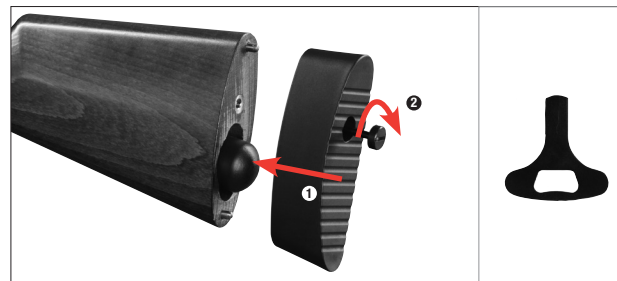

- 1 Colocar la cantonera.
- 2 Apretar el tornillo con la llave.



## CARGAR EL ARMA



### ATENCIÓN

Procure que la boca del cañón apunte siempre en una dirección segura.

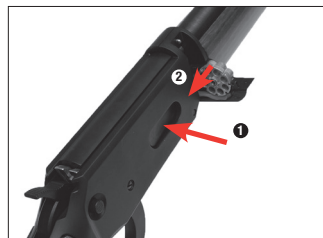

- 1 Presionar la trampilla. El brazo basculante se abre.
- 2 Extraer el tambor.



- 1 Insertar el tambor cargado. Comprobar que el tambor está en la posición correcta.
- 2 Cerrar el brazo basculante.

**IMPORTANTE:** Después de insertar el tambor nuevo se deberá repetir una vez para ponerlo en posición.



## CARGAR EL CARGADOR DE TAMBOR

ES



### ATENCIÓN

No use bolas de acero (los denominados proyectiles BBs), dardos o munición inapropiada similar. Use únicamente balines diábolo de calibre 4,5 mm (.177) con una longitud máxima de 6,5 mm.

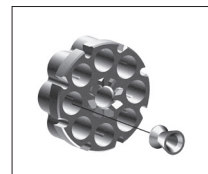

Cargar el tambor con balines diábolo.

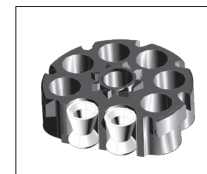

¡Comprobar que los diábolos están en la posición correcta!



## REPETIR Y DISPARAR

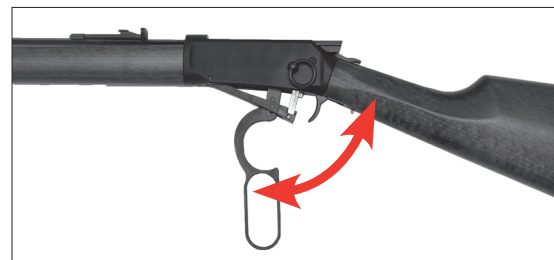

Bajar de todo la palanca inferior y volver a subirla hasta encajarla.



ES



## REPETIR Y DISPARAR



## INCEPPAMENTO

### ATENCIÓN

Si se dispara un arma con presión de CO<sub>2</sub> insuficiente el balín diábolo podría quedar atascado en el cañón.

Introducir un cartucho de CO<sub>2</sub> de 88 g lleno. Disparar con el cargador de tambor vacío. El balín atascado saldrá disparado.

Si no es así, extraiga el balín atascado en el cañón empujándolo hacia atrás con un cepillo limpiador.

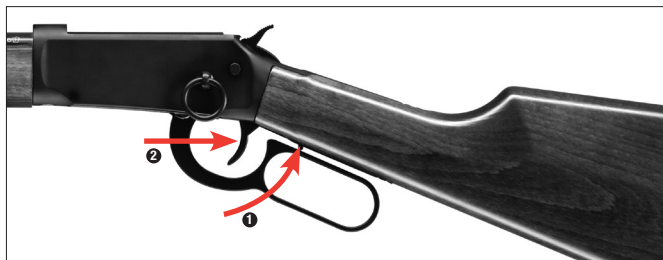

- 1 Presionar la palanca inferior hacia el arma y mantener presionada mientras se dispara (aseguramiento del gatillo).
- 2 Apretar el gatillo.





## AJUSTES DE LA MIRA

ES

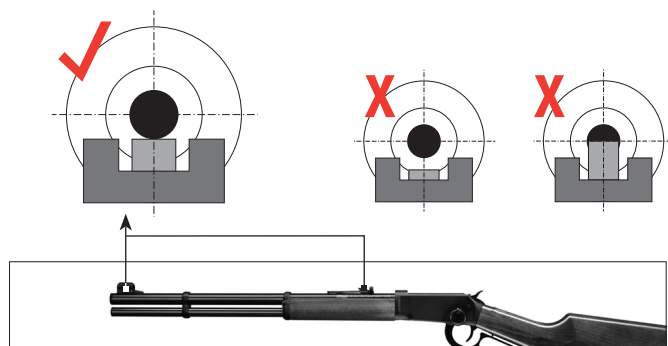

### Ajuste en altura (alza)

La altura se ajusta desplazando la muesca de regulación del alza.

- Tiro alto = Desplazar el regulador hacia adelante
- Tiro bajo = Desplazar el regulador hacia atrás

### Ajuste lateral (punto de mira)

El ajuste lateral se realiza desplazando el punto de mira. Para ello, retirar el cubrepunto.

- Tiro a la derecha = desplazar hacia la derecha
- Tiro a la izquierda = desplazar hacia la izquierda

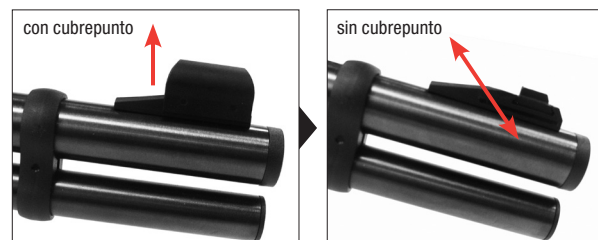
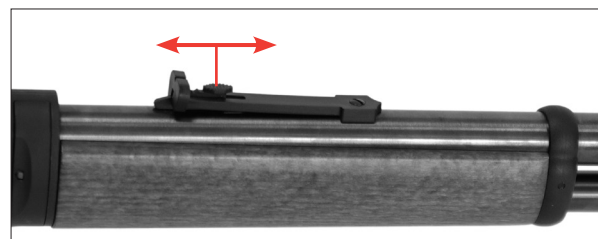



IT



## UTILIZZO SICURO DELLE ARMI



### DESCRIZIONE



### UTILIZZO



### MANUTENZIONE



### INDICAZIONI DI SICUREZZA

E' necessario mettersi nelle condizioni di maneggiare in modo corretto e sicuro la propria arma. Nell'ottica delle regole fondamentali per tirare in sicurezza, ricordare sempre che toccare un'arma significa maneggiarla.

- Trattare l'arma sempre come se fosse carica.
- Tenere il dito sempre al di fuori della guardia, e toccare il grilletto solo immediatamente prima di sparare.
- Utilizzare solo i proiettili indicati per quest'arma (munizioni).
- Puntare la bocca dell'arma sempre in una direzione sicura.
- Il tiro è ammesso soltanto all'interno della propria abitazione, in poligoni abilitati dalle autorità di polizia e su terreni con recinti che non possano essere oltrepassati dai proiettili. Considerare a tale scopo la gittata massima del proiettile.
- Non trasportare mai un'arma carica. Caricarla solo se si intende sparare.
- Non indirizzare mai l'arma verso persone o animali. Evitare i rimbalzi del proiettile. Non sparare mai su superfici lisce o dure, o su uno specchio d'acqua.
- Prima di sparare assicurarsi della sicurezza del bersaglio e delle sue immediate vicinanze.
- Controllare sempre che l'arma sia scarica prima di trasportarla o prima di prenderla in consegna da un'altra persona.
- Assicurarsi di poter controllare la direzione della volata anche se si sta inciampando o cadendo.
- Per motivi di sicurezza consigliamo di indossare gli occhiali di protezione durante il tiro.
- Conservare l'arma sempre in modo sicuro, scarica ed al di fuori dalla portata di persone non autorizzate (inesperti, bambini, persone di età inferiore ai 18 anni) e separata dalle munizioni.
- Il passaggio di proprietà dell'arma è consentito solamente se essa è corredata dalle istruzioni per l'uso, a persone di età superiore ai 18 anni, e soltanto a condizione che queste persone sappiano maneggiare perfettamente l'arma.
- Qualsiasi intervento o lavoro di riparazione dell'arma dovrà essere effettuato esclusivamente da armaioli esperti o da ditte specializzate.
- Non lasciare mai incustodita un'arma carica.
- Scaricare sempre l'arma prima di consegnarla ad altre persone.



INDICAZIONI DI SICUREZZA



MANUTENZIONE

IT



## ATTENZIONE

Per la vostra e per l'altrui sicurezza, leggete attentamente e completamente le istruzioni di montaggio prima di usare l'arma per la prima volta. L'acquirente ed il detentore dell'arma hanno l'obbligo di seguire tutte le regole vigenti per il possesso e l'utilizzo delle armi ad aria compressa. Qualsiasi modifica apportata all'arma è inammissibile in quanto può comportare una variazione della classificazione secondo le norme vigenti sul possesso delle armi. In questo caso la garanzia del produttore decade con effetto immediato.

### Note relative alla carabina CO<sub>2</sub> Lever Action

Prestare attenzione affinché le mani non vengano a contatto con il gas CO<sub>2</sub> che fuoriesce dall'arma. Il contatto con la pelle potrebbe provocare congelamenti. Non esporre le bombolette CO<sub>2</sub> a fonti di calore eccessive e non conservarle in contenitori esposti a temperature superiori ai 54°C. Osservare sempre le avvertenze e le norme di sicurezza del produttore relative all'utilizzo e alla conservazione delle bombolette CO<sub>2</sub>.

## GARANZIA

Entro un anno dalla data di acquisto, la ditta Umarex Sportwaffen GmbH & Co KG procede gratuitamente alla riparazione o sostituzione dell'arma, a condizione che il difetto non sia imputabile all'utilizzatore. Affidate l'arma ad un rivenditore autorizzato, descrivete il problema e consegnate la prova di acquisto.

Le armi ad aria compressa prodotte dalla ditta Umarex Sportwaffen GmbH & Co KG ditta vengono costruite in conformità ai requisiti di certificazione dell'Ente federale fisico-tecnico (Physikalisch-Technische Bundesanstalt PTB), alle leggi federali, alla normativa CIP e in base al know how acquisito dalla ditta Umarex Sportwaffen GmbH & Co KG nella fabbricazione di armi sportive.

In caso di esportazione all'estero, il produttore declina qualsiasi responsabilità per la non conformità dell'arma alle norme vigenti nel paese di destinazione nonché per eventuali difficoltà giuridiche e le relative conseguenze che ne potrebbero risultare per il proprietario/acquirente.

## RIPARAZIONE

Un'arma che non funziona perfettamente è pericolosa. È molto difficile riparare autonomamente un'arma, e un assemblaggio non corretto può determinare pericolosi malfunzionamenti. Attenzione: Far controllare e riparare l'arma esclusivamente da un rivenditore/armaiolo autorizzato.

## MANUTENZIONE

Ripulire le parti metalliche con uno straccio morbido imbevuto d'olio per armi.

## PROBLEMI

PROBLEMI	Possibili cause					
	Bomboletta CO <sub>2</sub> da 88 g CO <sub>2</sub>	Canna sporca	Bomboletta CO <sub>2</sub> da 88 g non correttamente avvitata	Temperature estreme	Munizioni sbagliate	Munizioni caricate in modo errato
Scarsa precisione	●	●		●	●	●
L'arma non spara	●		●		●	
Velocità ridotta del proiettile	●	●		●	●	●



IT



## DESCRIZIONE

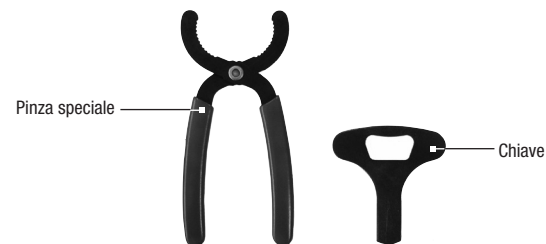



CARATTERISTICHE TECNICHE



SICURA

IT

### LEVER ACTION

Sistema	CO <sub>2</sub> , ripetizione a leva
Calibro	4.5 mm (.177)
Capacità del caricatore	8 colpi
Lunghezza totale	996 mm
Lunghezza della canna	480 mm (18.9 pollici)
Peso (senza bomboletta)	2800 g
Velocità di uscita pallino (energia)	175 m/s (7.5 J)
Propellente	Bomboletta CO <sub>2</sub> da 88 g
Grilletto	Single-Action-Only (azione semplice)
Tacca di mira	Tacca di mira regolabile in altezza Mirino regolabile in altezza



### ATTENZIONE

Maneggiare l'arma solo quando la sicura è attivata. Badare sempre a che la volata sia orientata in una direzione sicura.





## INSERIMENTO / SOSTITUZIONE DELLA BOMBOLETTA CO<sub>2</sub>

### ATTENZIONE

Durante la sostituzione della bomboletta di CO<sub>2</sub> da 88 g potrebbe verificarsi una leggera fuoriuscita di gas CO<sub>2</sub>. Prima di custodire l'arma, estrarre la bomboletta CO<sub>2</sub>.

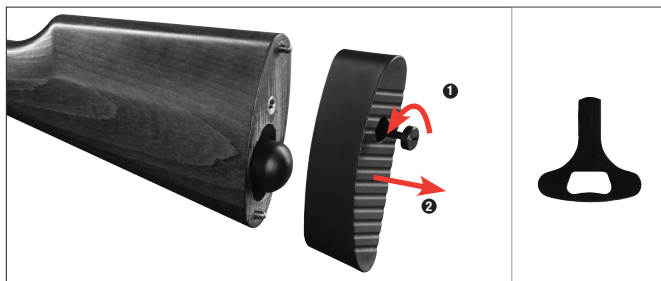

- 1 Allentare la vite con la chiave.
- 2 Estrarre il calciolo verso dietro.



- 1 Avvitare la bomboletta CO<sub>2</sub> da 88 g nel calciolo, con l'estremità sottile rivolta in avanti.
- 2 Stringere a fondo con la pinza speciale.



Svitare la bomboletta CO<sub>2</sub> da 88 g con la pinza speciale.

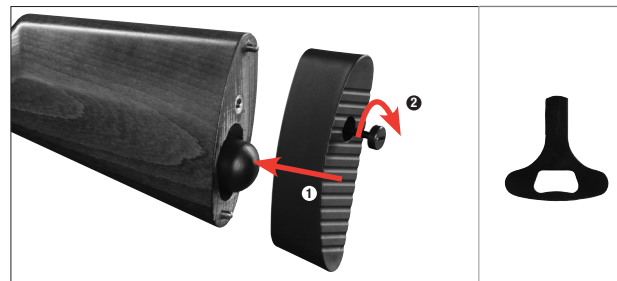

- 1 Mettere a posto il calciolo.
- 2 Stringere a fondo la vite con la chiave.



## CARICARE LA CARABINA

### ATTENZIONE

Badare sempre a che la volata sia orientata in una direzione sicura.

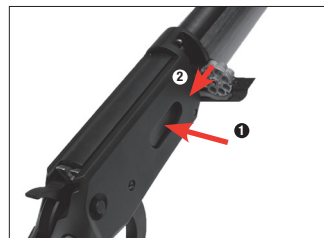

- ❶ Infiggere la botola di caricamento. Il braccio oscillante esce.
- ❷ Estrarre il tamburo.



- ❶ Inserire il tamburo carico. Verificare la corretta posizione del tamburo.
- ❷ Chiudere il braccio oscillante.

**IMPORTANTE:** Dopo l'inserimento di un nuovo tamburo occorre un'azione di ripetizione per assicurare il corretto posizionamento del tamburo.



## CARICARE IL TAMBURO

IT

### ATTENZIONE

Non utilizzare pallini tondi d'acciaio (i cosiddetti BB), piumini o altri proiettili non idonei. Impiegare soltanto diavolo cal. 4,5 mm (.177) con lunghezza max. di 6,5 mm.

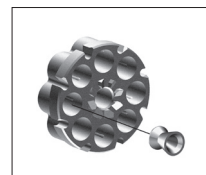

Caricare il tamburo con i diavolo.

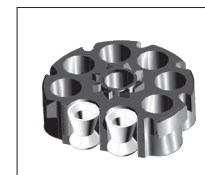

Badare alla posizione corretta dei diavolo.



## RIPETERE E SPARARE

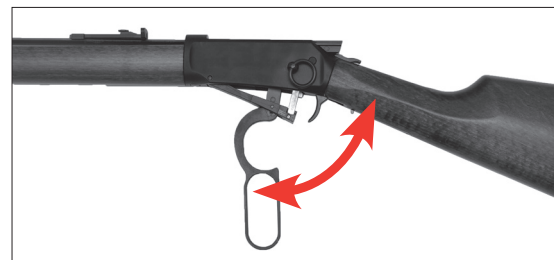

Abbassare completamente la leva sotto il grilletto e rialzarla fino all'incastro.



IT



## RIPETERE E SPARARE



## INCEPPAMENTO



### ATTENZIONE

Il tiro con una carabina con pressione CO<sub>2</sub> insufficiente può far sì che un diablo rimane in canna.

Inserire una bomboletta CO<sub>2</sub> piena. Sparare con il tamburo vuoto.  
Il diablo rimasto bloccato verrà così espulso

Se non si riesce a risolvere il problema, rimuovere il diablo dall'arma con uno scovolo, spingendolo indietro.



- 1 Appoggiare la leva sotto il grilletto contro la carabina e mantenerla ferma durante il tiro (sicura del grilletto). Azionare il grilletto.
- 2 Azionare il grilletto.





## REGOLAZIONE DELLA MIRA

IT

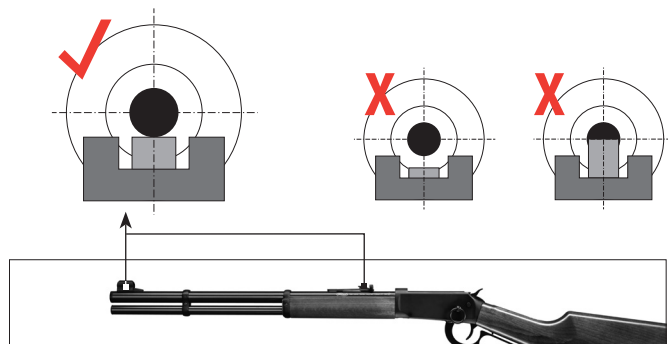

### Regolazione in altezza (tacca di mira)

La regolazione in altezza avviene spostando la tacca.

Colpo alto = spostamento in avanti

Colpo basso = spostamento indietro

### Regolazione laterale (mirino)

La regolazione laterale avviene spostando il mirino. A questo scopo rimuovere il cappuccio.

Tiro a destra = spostamento a destra

Tiro a sinistra = spostamento a sinistra

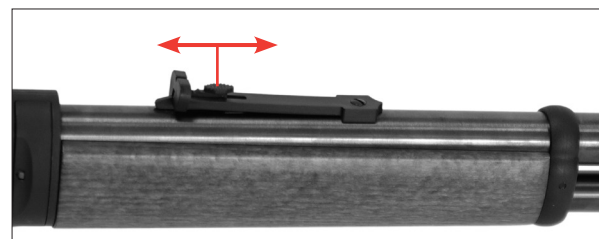

con cappuccio



senza cappuccio

**НАИМЕНОВАНИЕ**

**ОБСЛУЖИВАНИЕ**

**УХОД**

**ПРАВИЛА ТЕХНИКИ БЕЗОПАСНОСТИ**

Необходимо знать, как правильно и безопасно обращаться с оружием. С точки зрения основных правил безопасной стрельбы, помните, что каждое соприкосновение с оружием считается манипуляцией с ним.

- Обращайтесь с любым оружием так, как если бы оно было заряжено.
- Никогда не держите палец на спусковом крючке; класть палец на спусковой крючок можно только для выстрела.
- Используйте только предназначенные для этого оружия патроны.
- Всегда держите дуло оружия в безопасном направлении.
- Стрельба разрешается только в собственной квартире или доме, на стрелковых стендах, имеющих соответствующий допуск органов правопорядка (полиции), и на огороженных частных территориях, при условии, что заряд при стрельбе не сможет покинуть пределы этой территории. При этом необходимо соблюдать опасную зону данного патрона.
- Транспортировка оружия в заряженном состоянии строго запрещена. Всегда заряжайте его непосредственно перед выстрелом.
- Никогда не направляйте оружие на людей или животных. Избегайте рикошетов. Ни в коем случае не стреляйте в гладкие жесткие поверхности или в направлении водных поверхностей.
- Перед выстрелом убедитесь в безопасности цели и выстрела для окружающих.
- Всегда проверяйте, чтобы оружие не было заряжено при транспортировке или при получении его от другого лица.
- Убедитесь в том, что Вы способны контролировать направление дула оружия при падении или если споткнётесь.
- Из соображений безопасности при стрельбе необходимо всегда надевать защитные очки.
- Всегда храните оружие в разряженном виде и недоступном месте во избежание несанкционированного использования (лицами, не прошедшими специальный инструктаж, детьми, а также лицами в возрасте до 18 лет), отдельно от патронов.
- Передача оружия возможна только вместе с инструкцией по эксплуатации и только лицам старше 18 лет, которые самым подробным образом знают, как обращаться с этим оружием.
- Любые изменения в конструкции оружия или его ремонт должны производиться только в специализированных фирмах или оружейным мастером.
- Никогда не выпускайте из рук заряженного оружия.
- Передача оружия другому лицу возможна, только если оружие разряжено.



## ПРАВИЛА ТЕХНИКИ БЕЗОПАСНОСТИ



## УХОД

RU



### ВНИМАНИЕ

В целях Вашей собственной безопасности и безопасности других внимательно прочтите всю инструкцию по эксплуатации, прежде чем впервые выполнять какие-либо действия с оружием. Покупатель и владелец оружия обязаны соблюдать все правила пользования и владения пневматическим оружием. Любое изменение конструкции этого оружия может привести к изменению категории оружия и потому недопустимо. В этом случае гарантийные обязательства производителя немедленно теряют силу.

#### Инструкции к пневматическому ружью с CO<sub>2</sub> Lever Action

Следить за тем, чтобы не допустить контакта рук с выходящим газом CO<sub>2</sub>. При контакте с кожей могут возникнуть обморожения. Не подвергать баллоны с CO<sub>2</sub> воздействию слишком высоких температур и не хранить баллоны при температурах выше 54°C. Всегда строго соблюдать напечатанные на баллоне с CO<sub>2</sub> предупреждения и правила техники безопасности, подготовленные изготовителем и касающиеся обращения с баллоном с CO<sub>2</sub> и его хранения.

## ГАРАНТИЯ

Фирма Umarex Sportwaffen GmbH & Co KG бесплатно осуществит ремонт или замену оружия в течение установленного законом периода времени со дня покупки, если неисправность возникла не по вине владельца. Передайте оружие продавцу, имеющему соответствующую лицензию, опишите проблему и приложите документ, подтверждающий покупку.

Пневматическое оружие производства фирмы Umarex Sportwaffen GmbH & Co KG изготавливается в соответствии с правилами Федерального физико-технического института (РТВ), регламентирующими допуск к эксплуатации, федеральным законом, нормами CIP и оружейно-техническим ноу-хау фирмы Umarex Sportwaffen GmbH & Co KG.

Таким образом, мы не несём ответственности за экспортированное за границу оружие, если оно не соответствует действующим в этой стране нормативным актам, или при возникновении у владельца /покупателя трудностей юридического характера, повлекших за собой соответствующие последствия.

В России гарантийный срок продолжаться шесть месяцев.

## РЕМОНТ

Не функционирующее безупречно оружие опасно. Ремонт оружия – сложное дело, а неправильная сборка оружия может привести к опасным отказам. Внимание: Доверяйте осмотр и ремонт оружия только специалистам в специализированных магазинах или уполномоченному оружейному мастеру.

## УХОД

Чистку наружных металлических деталей выполнять мягкой салфеткой, предварительно слегка смоченной оружейным маслом.

## ПРОБЛЕМЫ

ПРОБЛЕМЫ	Возможные причины					
	Баллончик с CO <sub>2</sub> 88 г	Загрязнен ствол	Неправильно привинчен баллончик с CO <sub>2</sub> 88 г	Экстремальные температуры	Неправильные патроны	Патроны неправильно заряжены
неудовлетворительные баллистические качества	●	●		●	●	●
оружие не стреляет	●		●		●	
низкая скорострельность	●	●		●	●	●



RU



НАИМЕНОВАНИЕ





## ТЕХНИЧЕСКИЕ ХАРАКТЕРИСТИКИ



## ПРЕДОХРАНИТЕЛЬ

RU

LEVER ACTION	
Система	CO <sub>2</sub> -Lever-Action
Калибр	4,5 мм (.177)
Емкость магазина	8 выстрелов
Общая длина	996 мм
Длина ствола	480 мм (18,9 дюймов)
Вес (без магазина)	2800 г
Скорость у дульного среза (энергия)	175 м/с (7,5 Дж)
Привод	Баллончик с CO <sub>2</sub> 88 г
Спусковой крючок	только однозарядный
Прицел	регулируемая по высоте прорезь регулируемая по высоте мушка

### ВНИМАНИЕ

Манипуляции с оружием допускаются только в том случае, если оно поставлено на предохранитель. Всегда следите за тем, чтобы дуло оружия было направлено в безопасную сторону.





RU



## УСТАНОВКА / ЗАМЕНА БАЛЛОНЧИКА С CO<sub>2</sub>

### ⚠ ВНИМАНИЕ

При извлечении баллончика с CO<sub>2</sub> весом 88 г может выйти небольшое количество CO<sub>2</sub>. При постановке ружья на хранение обязательно снимать с него 88-граммовый баллончик с CO<sub>2</sub>!

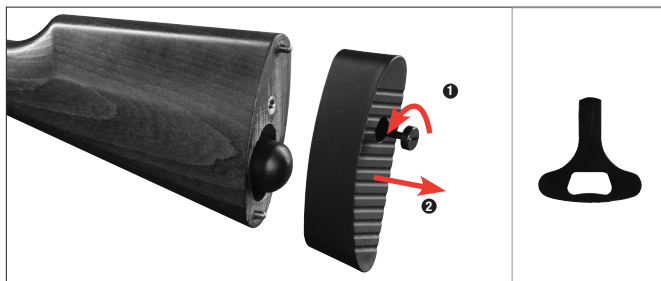

- 1 Отвинтить винт ключом.
- 2 Потянуть назад затыльник приклада.



- 1 Сначала ввинтить баллончик 88 г CO<sub>2</sub> узким концом в ложу.
- 2 Затянуть специальными клещами.



Выкрутить баллончик с CO<sub>2</sub> 88 г специальными клещами.

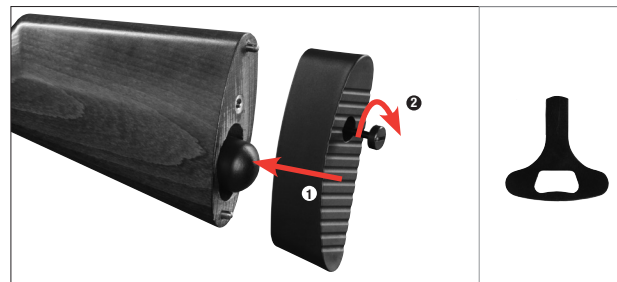

- 1 Установить на место затыльник приклада.
- 2 Затянуть винт ключом.



## ЗАРЯЖАНИЕ ОРУЖИЯ

### ВНИМАНИЕ

Всегда следите за тем, чтобы дуло оружия было направлено в безопасную сторону.



- 1 Нажать на зарядную дверцу. Поворотный рычаг откидывается.
- 2 Вынуть магазин.



- 1 Установить заряженный барабан. Соблюдать правильное положение барабана (защелки сзади).
- 2 Закрыть поворотный рычаг.

**ВАЖНО:** После каждой установки нового барабана необходимо один раз выполнить подачу патрона, чтобы привести барабан в правильное положение.



## ЗАРЯЖАНИЕ БАРАБАННОГО МАГАЗИНА

RU

### ВНИМАНИЕ

Использование круглых стальных пуль (так называемых ВВ), пружинных болтов или аналогичных неподходящих патронов запрещено. Использовать только патроны Diabolos кал. 4,5 мм (.177) с максимальной длиной пули 6,5 мм.

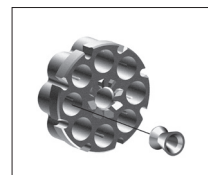

Зарядить барабан патронами «Diabolos».

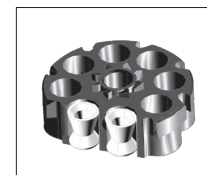

Соблюдать правильное положение пуль Diabolo.



## ПОДАЧА ПАТРОНОВ И СТРЕЛБА

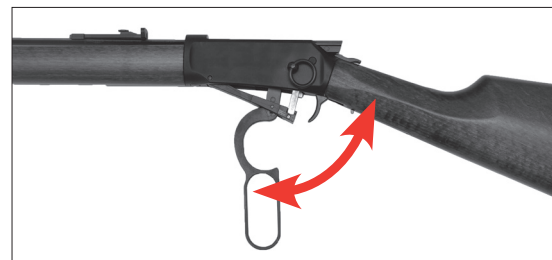

Полностью опустить вниз, а затем снова поднять нижний рычаг до фиксации.



RU



## ПОДАЧА ПАТРОНОВ И СТРЕЛЬБА



## ЗАДЕРЖКА ПРИ ЗАРЯЖАНИИ



### ВНИМАНИЕ

Стрельба из ружья со слишком низким давлением CO<sub>2</sub> может привести к застреванию «диабла» в стволе.

Установить заполненный баллончик с CO<sub>2</sub> 88 г. Выстрелить с пустым барабанным магазином. Это позволяет выстрелить застрявшую пулю «диабло».

Если устранить проблему не удается, необходимо вытолкнуть находящуюся в стволе пулю «диабло» из ружья с помощью щетки для чистки оружия.

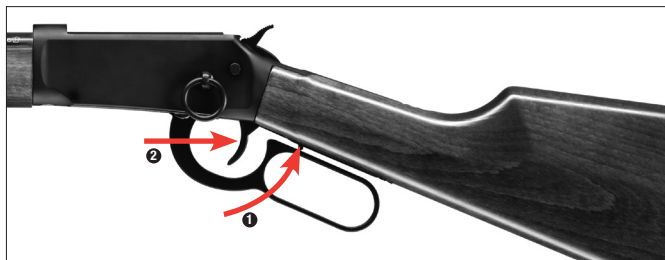

- 1 Прижать нижний рычаг к ружью и держать прижатым во время стрельбы (предохранитель спуска).
- 2 Потянуть спусковой крючок.





## НАСТРОЙКИ ПРИЦЕЛА

RU

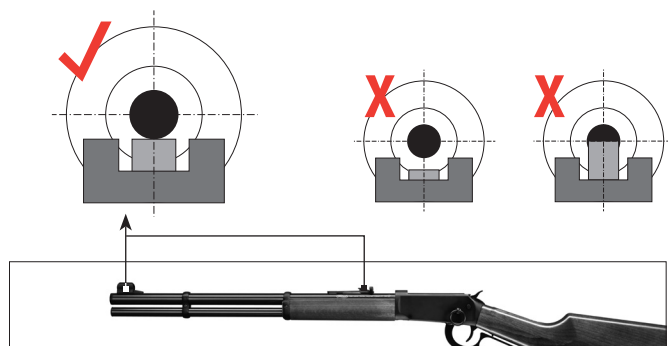

### Регулирование по высоте (прицел)

Регулирование по высоте осуществляется путем перемещения фиксатора на прицеле.

Перелет = передвинуть вперед  
Ниже центра цели = передвинуть назад

### Боковая регулировка (мушка)

Боковая регулировка осуществляется путем перемещения мушки. Для этого необходимо снять насадку.

Отклонение выстрела вправо = сдвинуть вправо  
Отклонение выстрела влево = сдвинуть влево

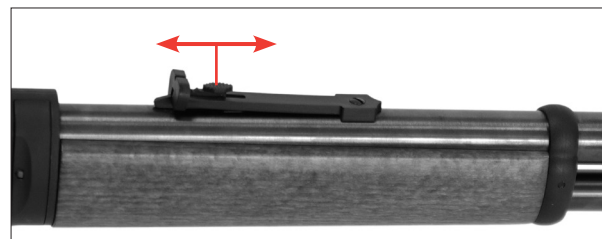

**NAZEWNICTWO**

**OBSŁUGA**

**KONSERWACJA**

**ZASADY BEZPIECZEŃSTWA**

Użytkownik powinien umieć prawidłowo i bezpiecznie posługiwać się swoją bronią. Mając na uwadze podstawowe zasady bezpiecznego strzelania, należy pamiętać, że każdy kontakt z bronią rozumiany jest jako obsługa.

- Z każdą bronią obchodzić się tak, jakby była naładowana.
- Palec trzymać zawsze poza kłębkiem spustu i kłaść do na spust tylko do strzału.
- Stosować tylko amunicję przeznaczoną dla danego rodzaju broni.
- Wylot lufy trzymać zawsze w bezpiecznym kierunku.
- Strzelanie dozwolone jest tylko we własnym mieszkaniu, na strzelnicach posiadających zezwolenie Policji i na ogrodzonych posiadłościach, jeżeli pocisk nie jest w stanie wylecieć przy wystrzale poza ich obszar. Pamiętać przy tym o strefie zagrożenia pocisku.
- Nigdy nie transportować naładowanej broni. Ładować broń dopiero przed oddaniem strzału.
- Nigdy nie kierować broni na ludzi i zwierzęta. Unikać rykoszetów. Nigdy nie strzelać w gładkie, twarde powierzchnie, ani w powierzchnię wody.
- Przed strzałem upewnić się, że cel i otoczenie są bezpieczne.
- Zawsze sprawdzać, czy broń jest nienaładowana, transportując ją lub przejmując od innej osoby.
- Upewnić się, że nawet w przypadku potknięcia się lub upadku będzie można kontrolować kierunek wylotu lufy.
- Ze względów bezpieczeństwa podczas strzelania nosić okulary ochronne.
- Broń przechowywać zawsze w bezpieczny sposób, nienaładowaną i zabezpieczoną przed dostępem osób niepowołanych (osoby nieprzeszkolone, dzieci, osoby poniżej 18. roku życia) i oddzielnie od amunicji.
- Broń przekazywać tylko wraz z instrukcją obsługi i tylko osobom powyżej 18. roku życia zaznajomionym dokładnie z obsługą tej broni.
- Wszelkie modyfikacje i naprawy broni muszą być przeprowadzane wyłącznie przez wykwalifikowane firmy lub rusznikarza.
- Nigdy nie wypuszczać z rąk naładowanej broni.
- Broń przekazywać innym osobom tylko w stanie nienaładowanym.



## ZASADY BEZPIECZEŃSTWA



## KONSERWACJA

PL



### UWAGA

Dla bezpieczeństwa własnego i innych osób przed pierwszym kontaktem z bronią należy starannie przeczytać całą instrukcję obsługi. Kupujący i właściciele zobowiązani są przestrzegać wszystkich zasad dotyczących użytkowania i posiadania broni pneumatycznej. Każda modyfikacja broni może spowodować zmianę jej kwalifikacji i jest tym samym niedozwolona. W takim przypadku natychmiast wygasa gwarancja producenta.

#### Wskazówki dot. broni na kapsuły CO<sub>2</sub> Lever Action

Uważać, aby dłonie nie miały kontaktu z wydobywającym się gazem CO<sub>2</sub>. W przypadku kontaktu ze skórą może dojść do odmrożeń. Nie narażać kapsuł CO<sub>2</sub> na działanie wysokiej temperatury i nie przechowywać ich w temperaturze powyżej 54°C. Przestrzegać nadrukowanych na kapsule CO<sub>2</sub> ostrzeżeń i zasad bezpieczeństwa producenta dotyczących obsługi i przechowywania kapsuł CO<sub>2</sub>.

## GWARANCJA

W ustawowym okresie gwarancyjnym liczonym od daty zakupu firmę Umarex Sportwaffen GmbH & Co KG gwarantuje bezpłatną naprawę lub wymianę broni, o ile usterka nie została zawiniona przez użytkownika. Broń należy oddać w autoryzowanym punkcie sprzedaży, opisać problem i dołączyć dowód zakupu.

Broń pneumatyczna Umarex Sportwaffen GmbH & Co KG produkowana jest zgodnie z przepisami Federalnego Urzędu Fizyczno-Technicznego (PTB), niemieckiego ustawodawstwa, przepisami CIP oraz wiedzą techniczną firmę Umarex Sportwaffen GmbH & Co KG na temat broni.

Tym samym w przypadku eksportu towaru za granicę nie odpowiadamy za ewentualne problemy prawne właściciela/nabywcy wynikające z niezgodności towaru z przepisami obowiązującymi w danym kraju.

## NAPRAWA

Broń, która nie działa prawidłowo, jest niebezpieczna. Samodzielna naprawa broni jest trudna, a nieprawidłowy montaż może prowadzić do niebezpiecznych usterek działania. Uwaga: broń należy oddać do sprawdzenia i naprawy przez autoryzowany punkt sprzedaży lub rusznikarza.

## KONSERWACJA

Zewnętrzne części metalowe czyścić miękką szmatką nawilżoną oliwą do broni.

## PROBLEMY

PROBLEMY	Możliwe przyczyny					
	kapsuła CO <sub>2</sub> , 88 g	zanieczyszczona lufa	nieprawidłowo przykręcona kapsuła CO <sub>2</sub> , 88 g	ekstremalne temperatury	nieprawidłowa amunicja	nieprawidłowe naładowanie
niedostateczna siła strzału	●	●		●	●	●
broń nie strzela	●		●		●	
niska prędkość pocisku	●	●		●	●	●



PL



# NAZEWNICTWO

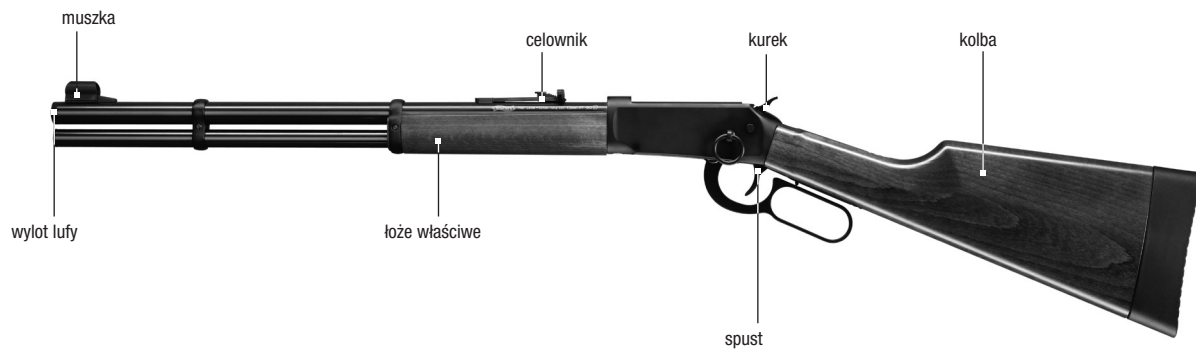



## DANE TECHNICZNE



## ZABEZPIECZENIE

PL

LEVER ACTION	
system	CO <sub>2</sub> -Lever-Action
kaliber	4.5 mm (.177)
pojemność magazynka	8 naboji
długość całkowita	996 mm
długość lufy	480 mm (18,9 cala)
masa (bez kapsuły)	2800 g
prędkość na wylocie z lufy (energia)	175 m/s (7,5 J)
napęd	kapsuła CO <sub>2</sub> 88 g
spust	Single-Action-Only
celownik	szczerbina o regulowanej wysokości muszka o regulowanej wysokości



## UWAGA

Manipulować bronią tylko wtedy, gdy jest zabezpieczona. Wylot lufy trzymać zawsze w bezpiecznym kierunku.





PL



## WKŁADANIE/WYMIANA KAPSUŁY CO<sub>2</sub>



### UWAGA

Przy wyjmowaniu kapsuły CO<sub>2</sub> 88 g może uwolnić się niewielka ilość CO<sub>2</sub>. Do przechowywania broni wyjąć kapsułę CO<sub>2</sub> 88 g!

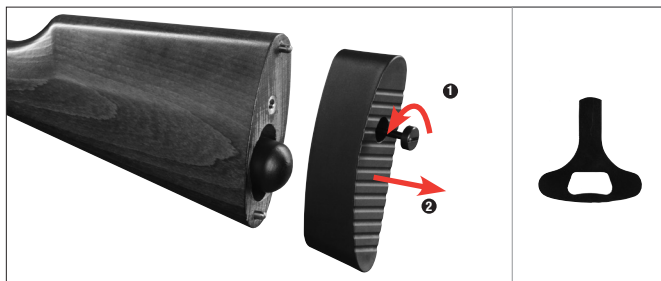

- 1 Odkręcić śrubę kluczem.
- 2 Zdjąć stopkę do tyłu.

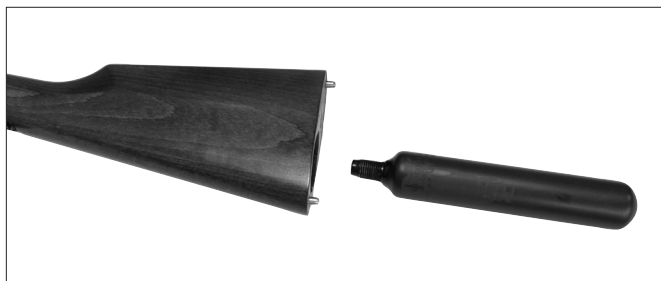

- 1 Wkręcić kapsułę CO<sub>2</sub> 88 g wąskim końcem w kolbę.
- 2 Dokręcić specjalnymi szczypcami.



Wykręcić kapsułę CO<sub>2</sub> 88 g specjalnymi szczypcami.

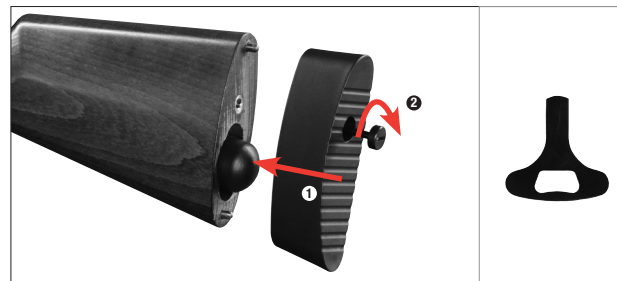

- 1 Założyć stopkę.
- 2 Dokręcić śrubę kluczem.



## ŁADOWANIE BRONI



### UWAGA

Wylot lufy trzymać zawsze w bezpiecznym kierunku.

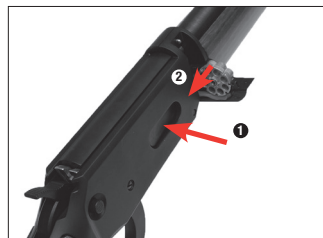

- 1 Wcisnąć port ładowania. Ramię uchylnie otwiera się.
- 2 Wyjąć bębenek.



- 1 Włożyć załadowany bębenek. Zwrócić uwagę, czy bębenek znajduje się w odpowiedniej pozycji (noski zatrzaskowe z tyłu).
- 2 Zamknąć ramię uchylnie.

**WAŻNE:** Po każdym włożeniu nowego bębena należy jeden raz repetywać broń, aby umieścić go w odpowiedniej pozycji.



## ŁADOWANIE MAGAZYNKA BĘBENKOWEGO

PL



### UWAGA

Nie stosować śrutu (tzw. BB), lotek pędzelkowych ani innych nienadających się do tego celu pocisków. Stosować wyłącznie śrut Diabolo kal. 4,5 mm (.177) o maksymalnej długości pocisku 6,5 mm.

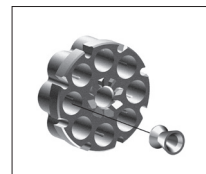

Załadować śrut Diabolo do bębena.

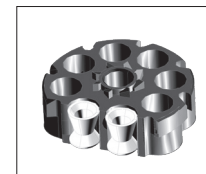

Zwrócić uwagę, czy śrut Diabolo znajduje się w odpowiedniej pozycji.



## REPETOWANIE I STRZELANIE

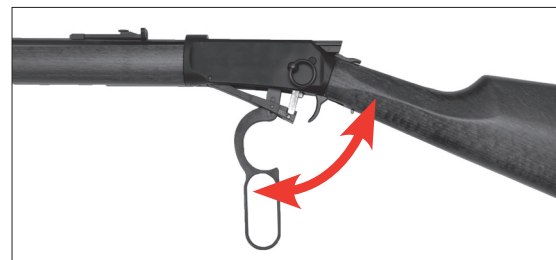

Naciąg dolny przesunąć całkowicie w dół, a następnie ponownie do góry aż do zatrzaśnięcia.



PL



## REPETOWANIE I STRZELANIE



## ZABLOKOWANIE ŁADUNKU



### UWAGA

Strzelanie przy zbyt niskim ciśnieniu CO<sub>2</sub> może prowadzić do utknięcia śrutu Diabolo w lufie.

Włożyć napelnioną kapsułę CO<sub>2</sub> 88 g. Strzelać z pustym magazynkiem.  
Następuje wystrzelenie śrutu Diabolo tkwiącego w lufie.

Jeśli to nie pomoże, wypchnąć śrut Diabolo z lufy do tyłu wyciorem.

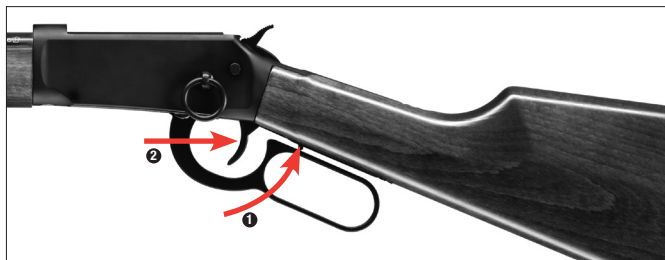

- 1 Naciąg dolny docisnąć do broni i podczas strzelania trzymać dociśnięty (zabezpieczenie spustu).
- 2 Pociągnąć spust.





## USTAWIANIE WIZJERA

PL

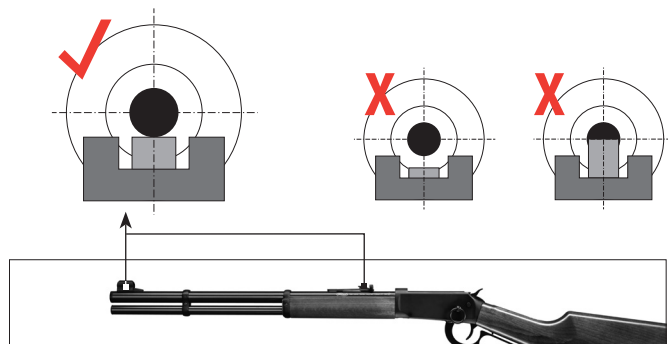

### Regulacja wysokości (celownik)

Regulacja wysokości odbywa się poprzez przesunięcie zapadki celownika.

zbyt wysoki strzał  
zbyt niski strzał

= przesunąć regulację do przodu  
= przesunąć regulację do tyłu

### Regulacja boczna (muszka)

Regulacja boczna odbywa się poprzez przesunięcie muszki. W tym celu zdjąć osłonkę.

odchylenie strzału w prawo  
odchylenie strzału w lewo

= przesunąć w prawo  
= przesunąć w lewo

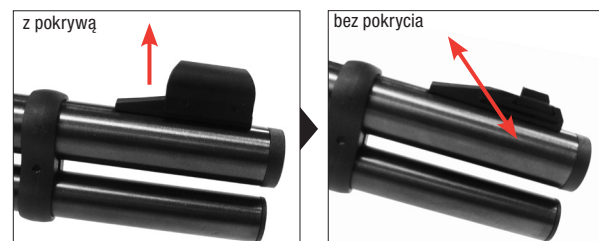
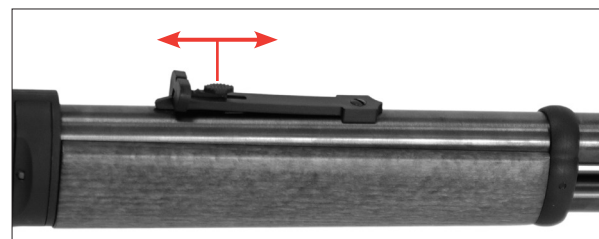

**PARÇALARIN ADLARI****KULLANIM****BAKIM****GÜVENLİK BİLGİLERİ**

Silahınızın doğru ve güvenli şekilde kullanımına vakıf olmanız gerekmektedir. Güvenli silah atmanın ana kuralları açısından, silah ile her türlü temasın kullanım olarak anlaşıldığını göz önünde bulundurun.

- Her silaha, sanki dolu imiş gibi muamele edin.
- Parmağınızı her zaman tetik koruyucusunun dışında tutun ve sadece ateşlemek için tetiğin üzerine koyun.
- Sadece, bu silahla kullanılması öngörülen mermileri (mühimmatı) kullanın.
- Namluyu her zaman emniyetli bir yöne tutun.
- Sadece kendi evinizde, polis tarafından izin verilen atış poligonlarında ve çit veya duvarlarla çevrili bir mülk içerisinde, merminin bu alanın dışına çıkamayacağı koşullarda atış yapılabilir. Merminin tehlike menzili hesabına katın.
- Hiçbir zaman silahlı dolu olarak taşımayın. Silahlı sadece atış yapmak istediğiniz zaman doldurun.
- Silahlı hiçbir zaman insanların veya hayvanların üzerine doğrultmayın. Kurşunların sekmeyeceği şekilde ateş etmeye dikkat edin. Hiçbir zaman kaygan, sert yüzeylere veya su yüzeylerine ateş etmeyin.
- Atış yapmadan önce hedefin ve çevredeki alanın güven altında olduğundan emin olun.
- Silahlı taşımadan önce veya başka birinden teslim aldıktan hemen sonra, dolu olup olmadığını kontrol edin.
- Tökezlemeniz veya düşmeniz halinde bile namlunun yönünü kontrol edebileceğinizden emin olun.
- Emniyet açısından atış sırasında koruyucu gözlük kullanılmalıdır.
- Silahlı daima emniyetli ve boş, mühimattan ayrı olarak ve yetkisiz kişilerin (eğitimi ve deneyimi olmayanların, 18 yaşın altında kişilerin) izinsiz erişemeyeceği şekilde saklayın.
- Bu silah kullanım kılavuzu ile beraber sadece, 18 yaşından büyük ve bu silahın kullanımına çok iyi vakıf olan kişilere verilebilirsiniz.
- Silahların üzerinde yapılacak her türlü değişiklik veya tamirat sadece uzman şirketler veya silah ustası tarafından yapılmalıdır.
- Hiçbir zaman dolu bir silahlı elden bırakmayın.
- Sadece boşaltılmış silahları başka kişilere verin.



## GÜVENLİK BİLGİLERİ



## BAKIM

TR



## DİKKAT

Hem kendinizin hem de başkalarının emniyeti için, silahı ile defa elinize almadan önce, bu kullanım kılavuzunu tam olarak ve itina ile okuyun. Bu silahları satın alan veya sahibi olan kişiler, havalı silahların kullanılması ve bulundurulması ile ilgili tüm kurallara uymakla yükümlüdürler. Bu silah üzerinde yapılacak her türlü değişiklik silah mevzuatına göre yapılan sınıflandırmanın değişmesine neden olabilir ve bu sebeple yasaktır. Üreticinin vermiş olduğu garanti bu durumda geçerliliğini derhal kaybeder.

**Bu CO2 tüfeği 18 yaş ve üstündeki kişiler tarafından serbestçe satın alınabilir.**

### Levye mekanizmalı CO2 tüfeğiyle ilgili uyarılar

Ellerinizin silahtan çıkan CO2 gazıyla temas etmemesine dikkat edin. Deri ile temas halinde deride donmalar oluşabilir. CO2 kapsülünü aşırı sıcak koşullara maruz bırakmayın ve bu kapları 54 °C'den daha sıcak ortamlarda saklamayın. CO2 kapsülü üzerinde yer alan, CO2 kapsülünün kullanımı ve saklanmasıyla ilgili basılı üretici uyarı ve güvenlik bilgilerine daima uyun.

## GARANTİ

Satış tarihinden sonraki bir yıl içerisinde, silahta oluşan arıza kendi hatanızdan dolayı oluşmamış ise, Umarex şirketi silahınızı ücretsiz olarak tamir eder veya karşılığında yenisini verir. Silahı yetkili bir satıcıya götürün, ona sorunu anlatın ve satış belgesini sunun.

UMAREX Sportwaffen GmbH & Co. KG tarafından üretilen havalı silahlar, Fizik ve Teknik ile ilgili Federal Daire'nin (PTB) ruhsatlandırma şartlarına, federal yasaya, CIP talimatlarına ve de UMAREX Sportwaffen GmbH & Co. KG şirketinin silah teknoloji konusundaki deneyimlerine dayanılarak üretilmektedir.

Bu sebeple, eğer bu silah yurt dışına ihraç edildikten sonra o ülkenin hükümlerine uymadığı tespit edilirse ve sahibi/alicisi bundan dolayı hukuki sorunlarla ve bunların sonuçları ile karşılaşarsa, şirketimiz herhangi bir mesuliyet kabul etmemektedir.

## TAMİR

Kusursuz çalışmayan bir silah tehlikelidir. Bir silahı kendi başınıza tamir etmeniz zordur ve yanlış monte edilmesi tehlikeli fonksiyon arızalarına neden olabilir.

Dikkat: Silahınızı sadece yetkili bir uzman satıcı/silah ustası tarafından kontrol ve tamir ettirin.

## BAKIM

Dış metal parçaları, daha önce silah yağıyla nemlendirilmiş yumuşak bir bez kullanarak temizleyin.

## PROBLEMLER

Problemler	Olası nedenler					
	88 g'lık CO2 kapsülü boş	Namlu kirlisi	88 g'lık CO2 kapsülü delinmemiş	Aşırı sıcak/soğuk	Yanlış mühimmat	Mühimmat yanlış doldurulmuş
Kötü atış performansı	●	●		●	●	●
Silah ateş almıyor	●		●		●	
Merminin hızı düşük	●	●		●	●	●



TR



## PARÇALARIN ADLARI

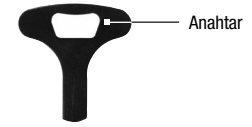
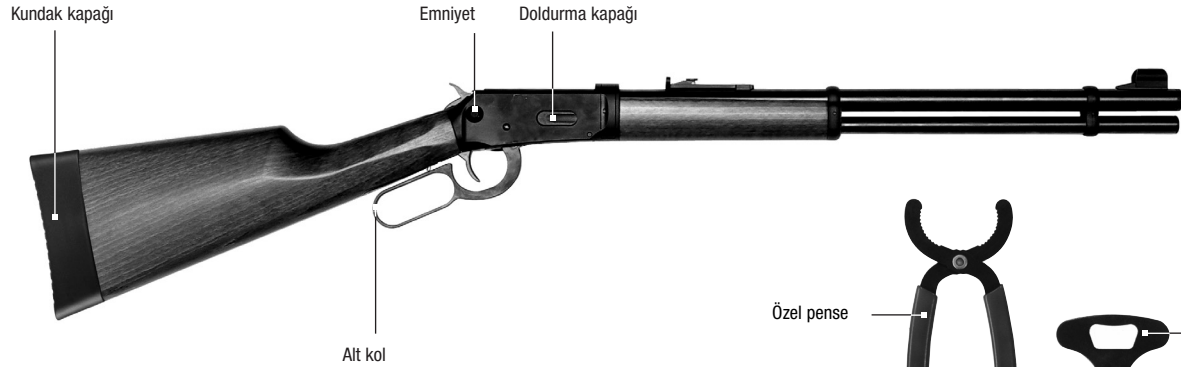
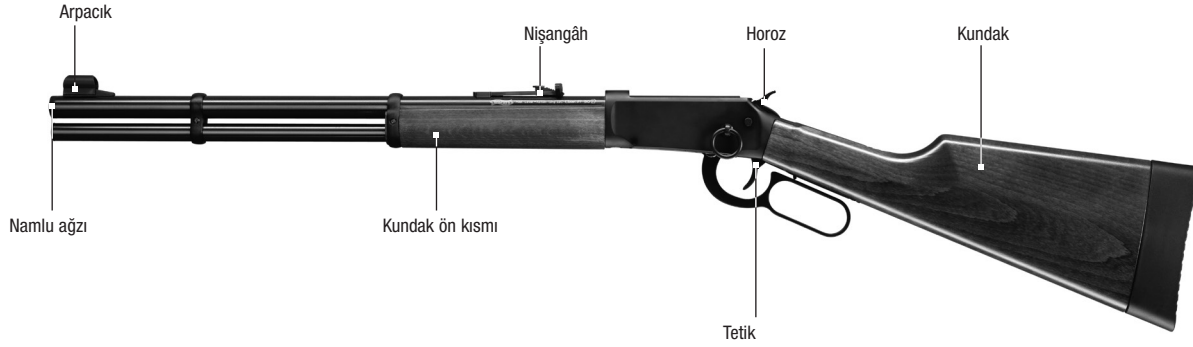



TEKNİK ÖZELLİKLER



EMNİYET

TR

### LEVYE MEKANİZMALI

<b>Sistem</b>	C02 Levye Mekanizmalı
<b>Kalibre</b>	4,5 mm (.177)
<b>Şarjör kapasitesi</b>	8 atış
<b>Toplam uzunluk</b>	996 mm
<b>Namlu uzunluğu</b>	480 mm (18,9 inç)
<b>Ağırlık (kapsül hariç)</b>	2800 g
<b>Namlu hızı (enerji)</b>	175 m/s (7,5 J)
<b>Çalışma şekli</b>	88 g'lık C02 kapsülü
<b>Tetik</b>	Sadece tek hareketli
<b>Nişangâh</b>	Yükseklik ayarlı gez, sağ-sol ayarlı arpacık

### ⚠ DİKKAT

Silahi sadece, emniyetsiz halde iken elinize alın. Namlunun her zaman güvenli bir yöne doğrultulmuş olmasına dikkat edin.





TR



## CO2 KAPSÜLÜNÜN YERLEŞTİRİLMESİ / DEĞİŞTİRİLMESİ



### DİKKAT

88 g'lık CO2 kapsülünü çıkarırken biraz CO2 sızabilir.  
Silahı saklamadan önce 88 g'lık CO2 kapsülünü çıkarın!

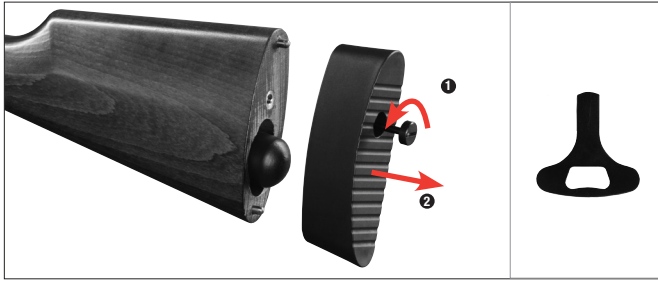

- 1 Vidayı anahtarla sökün.
- 2 Kundağ kapağını arkaya doğru çekip çıkarın.

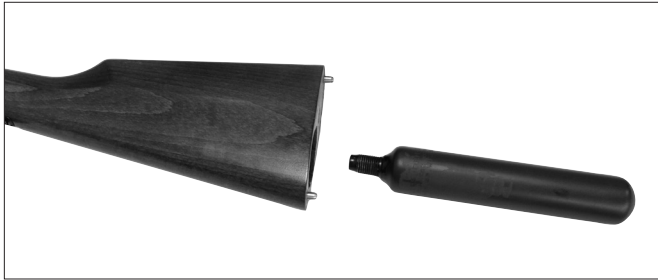

- 1 88 g'lık CO2 kapsülünü ince ucu öne gelecek şekilde tutarak kundağın içine vidalayın.
- 2 Özel penseyle sıkıca vidalayın.



88 g'lık CO2 kapsülünü özel pense yardımıyla çevirerek çıkarın.

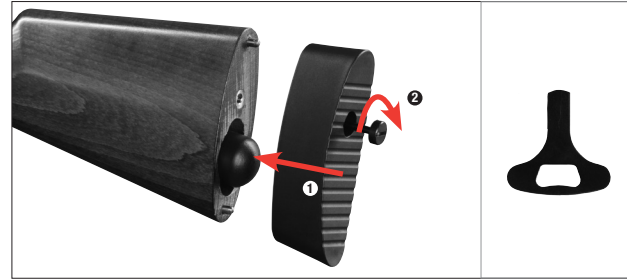

- 1 Kundağ kapağını yerine oturtun.
- 2 Anahtarı kullanarak vidayı sıkın.



## TÜFEĞİN DOLDURULMASI



### DİKKAT

Namlunun her zaman güvenli bir yöne doğrultulmuş olduğuna dikkat edin.

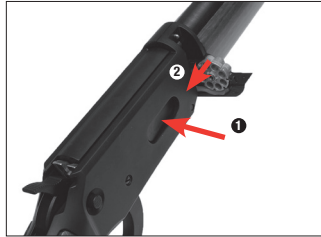

- 1 Doldurma kapağını içeriye doğru bastırın, döner kol açılır.
- 2 Topu çıkarın.

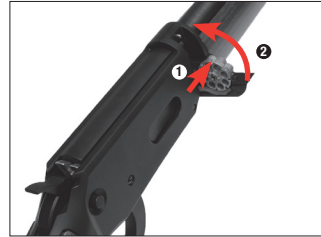

- 1 Doldurduğunuz topu yerleştirin. Topun doğru konumda olmasına dikkat edin (tırnaklar arkada).
- 2 Döner kolu kapatın.

**ÖNEMLİ: YENİ BİR TOP YERLEŞTİRİLDİĞİNDE, TOPU DOĞRU KONUMA GETİRMEK İÇİN SİLAH BİR KERE KURULMAK ZORUNDADIR.**



## TOPUN DOLDURULMASI

TR



### DİKKAT

Misket mermi (BB adı verilen saçmalar), yaylı saptama ve benzeri, bu silaha uygun olmayan mühimmat kullanmayın. Sadece azami çekirdek uzunluğu 6,5 mm olan cal. 4,5 mm (.177) Diabolo kullanın.

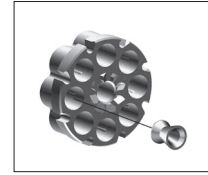

Topa Diabolo doldurun.

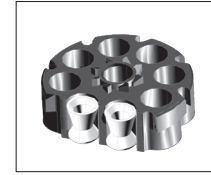

Diaboloaların doğru konumda olmalarına dikkat edin.



## KURMAK VE ATIŞ YAPMAK

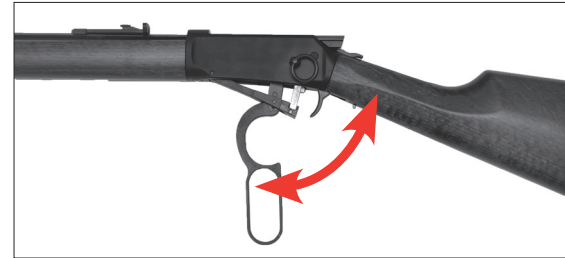

Alt kolu tamamen aşağıya hareket ettirin ve duyulabilir bir sesle yerine oturacak şekilde tekrar geri götürün.



TR



## KURMAK VE ATIŞ YAPMAK



## HAMOWANIE ŁADOWANIA



### ⚠ DİKKAT

CO2 basıncı fazla düşük olan bir tüfekle ateş etmek, namlunun içinde bir Diabolonun takılmasına neden olabilir.

Doldurulmuş 88 g'lık CO2 kapsülünü yerleştirin. Top boş haldeyken ateş yapın.  
Takılan Diabolo ile ateş yapılır.

Problem giderilmezse, namluda bulunan Diabolyu bir temizleme fırçasıyla arkaya doğru iterek tüfekten çıkarın.

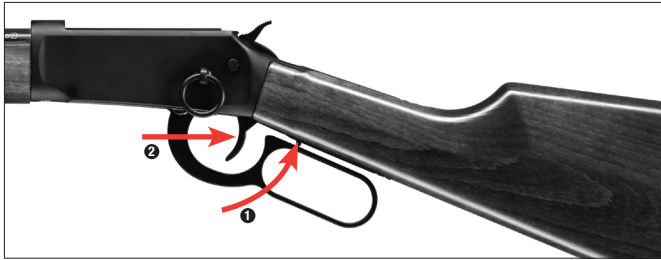

- 1 Alt kolu tüfek gövdesine doğru bastırın ve ateş sırasında basılı tutun (tetik emniyeti).
- 2 Tetiği çekin.





## NIŞANGÂHI AYARLAMAK

TR

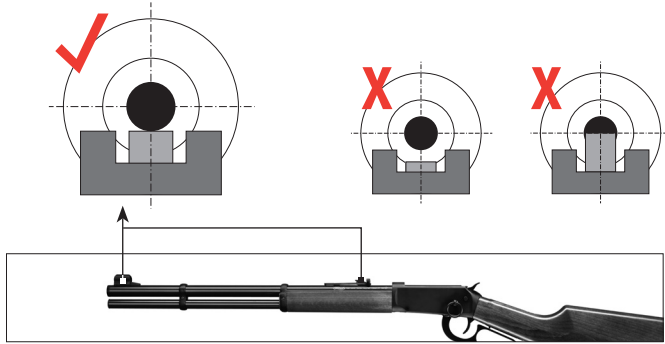

### Yükseklik ayarı (Nişangâh)

Yükseklik ayarı, nişangâh içindeki tırnak kaydırılarak gerçekleştirir.

Yüksek atış  
Alçak atış

= Ayar mekanizmasını öne doğru itin.  
= Ayar mekanizmasını arkaya doğru itin.

### Sağ-sol ayarı (arpacık)

Sağ-sol ayarı arpacık kaydırılarak gerçekleştirir. Bunun için arpacığın üstündeki başlığı çıkarın.

Sağa atış  
Sola atış

= Sağa doğru kaydırın.  
= Sola doğru kaydırın.

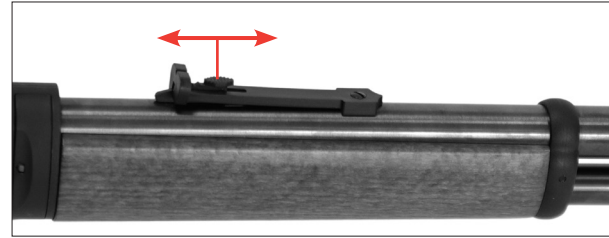







Distributed by

**UMAREX®**  
**WWW.UMAREX.COM**

P.O. Box 27 20

D-59717 Arnsberg | Germany

Phone: +49 29 32 / 638-01

Fax: +49 29 32 / 638-222

verkauf@umarex.de | sales@umarex.de

We reserve the right to make color and design changes and technical improvements. No responsibility is accepted for printing errors or incorrect information.

Änderungen in Farbe und Design, sowie technische Verbesserungen, Druckfehler und Irrtum vorbehalten. Alle Angaben ohne Gewähr.

Sous réserve de modifications de couleurs et de conception, d'améliorations techniques, de fautes d'impression et d'erreurs. Toutes les indications sont données sans garantie.

Sujeto a cambios de color y diseño así como a mejoras técnicas y errores de impresión. Todos los datos sin garantía.

Riserva di modifiche dei colori e del disegno, nonché di migliorie tecniche, errori di stampa e omissioni. Tutti i dati sono forniti senza garanzia.

Ответственность за отклонения по цвету и дизайну, а также технические исправления, опечатки и ошибки исключена. Все сведения приводятся без гарантий.

Zmiany koloru i wyglądu, jak również poprawki techniczne, błędy w druku i pomyłki zastrzeżone. Wszelkie dane bez gwarancji.

Renk, tasarım ve teknik değişiklikler yarma hakkı saklıdır. Baskı hatalarından ya da hatalı bilgilerden dolayı yasal sorumluluk kabul edilmez. Bilgiler için garanti verilmmez.

© UMAREX Sportwaffen GmbH & Co. KG